LOW VOLTAGE AC DRIVES

Solar pump drives

ACQ80, 0.75 to 200 kW



—

**ACQ80 delivers reliable operation,
using sustainable energy for
efficient pumping.**

Table of contents

04–05	ACQ80 solar pump drive family
06	ACQ80 drive software with invincible features
07	ACQ80 drive work principle
08	Environmentally friendly solution
09	ABB AC drives comply with the EU Ecodesign requirements
10	ACQ80-04 standard interface
11	ACQ80-01 and ACQ80-07 standard interface
12	How to select a drive
13	Technical data
14–15	Ratings, types and voltages
16	Dimensions
17	Pre-charging circuits
18–19	Cooling and fuses
20	EMC – electromagnetic compatibility
21	Input chokes, du/dt filters, C1 filters
22	An entirely new level of ease
24–25	Control panel options and mounting kits
26	ABB Ability™ Mobile Connect for drives
27	ABB Ability™ Digital Powertrain
28–29	Communication and I/O options
31	ABB GoSelect web-based tool
32	Tools for configuration, monitoring and process tuning
33	All-compatible ACQ80 solar pump drive
34–37	Summary of drive ordering codes
38–39	ABB Motion Services
40–41	ABB Drives Life Cycle Management

ACQ80 solar pump drive family

Using clean energy for sustainable life

Why solar pump?

Half the energy produced around the world is used to operate pumps. Compared to diesel generator pumps and grid operated pumps, the ABB solar pump drive is environmentally friendly, with a long lifetime and low maintenance costs. It can operate independently of the grid and produces no pollution or noise. Typical applications are irrigation, community water supply and agriculture.

ACQ80

All-compatible ACQ80 solar pump drives enhance the methodology of water pumping by putting the sun to work for all water pumping needs. From dawn to dusk, the drive operates without energy costs easily and safely, keeping CO₂ emissions to zero.

Built-in MPPT

The maximum power point tracking functionality ensures that you get the most power output possible from your solar panel and maximizes the performance of your pump throughout the day.



Best on-grid and off-grid solution

To get maximum water flow throughout the day and reduce grid power consumption, both grid and PV can be connected to the drive. For places where electricity is unpredictable, users need not depend on grid electricity for their water pumping requirements. Water pumping can be done via a PV power source as an off-grid solution.

Remote monitoring allows to configure drive and application parameters from anywhere via embedded Modbus RTU or multiple Fieldbus options.



The control panel features intuitive use and easy navigation. Control panel with Bluetooth functionality connected to the Drivetune mobile App provides easy and fast access to product information and support without opening the drive cabinet.

ABB solar pump drive is an innovative solution that uses solar power as a clean energy source for pumping water.

Pump-specific functionality

Multiple operating modes ensure water saving and optimal control of the pumping, based on the need and application: the solar radiation intensity, the desired time on any day of a week, manually with external push buttons, remote cellular-based control or based on the tank level.

Pump cleaning keeps the pump's impeller clean by running a sequence of aggressive ramps between minimum and maximum pump speed.

PID/Loop control

Static pressure or flow can be maintained without adding external controllers.

The flow calculation function measures the amount of water flowing without the need for external sensors, based on the pump characteristics data or the pulse count.

Dry run protection prevents the pump from running dry. If there is no water in the pump, released heat can damage the pump over time, limiting its lifetime.

The programmable protection functions generates warnings and faults based on external signals or internal monitoring for extended safety, reliability and an extended lifetime.

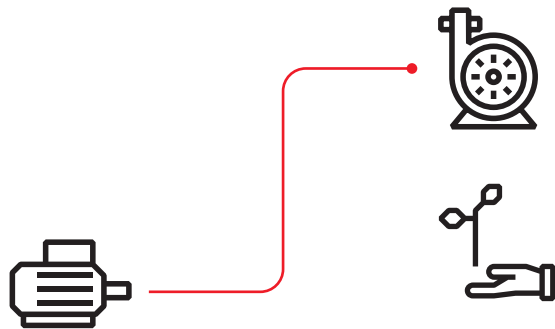

Support for multiple pump motor types

The drive has the ability to control standard asynchronous pump motors, as well as more efficient permanent magnet and permanent magnet assisted synchronous reluctance pump motors.

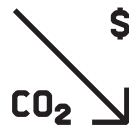

Low-carbon economy

By utilizing solar power, the drive can make daytime water pumping CO₂ emission-free and help reduce your carbon footprint.

ACQ80 drive software with invincible features



Best in class Maximum Power Point Tracking with cloud detection ensures continuous water pumping, even in low sunlight.

Ensure optimal pump operation with various start modes, pump control methods and protection functions.

Save commissioning and learning time with the assistant control panel's clear and intuitive user interface and various assistants.

Monitor the use of solar power to know the amount of motor energy consumption. You can monitor the hourly, daily and cumulative energy consumption via kWh counters.

Analyze and optimize the application with the load profile log, which shows you how the drive is operating. Monitor values that matter to you on multiple home view displays.

Operate the pumps efficiently at pump best efficiency point with maximum MPPT efficiency.

Save time with primary settings that enable quick access to the most commonly used parameters and settings, without the need to go through the complete parameter list.

Analyze and resolve issues with the control panel's diagnostics menu. You can quickly analyze why the drive is performing as it is.

Add flexibility with adaptive programming that offers an easy alternative for simple programming needs.

ACQ80 drive work principle

ACQ80 drives are intended to be used for speed control of 3-phase AC pump motors and powered from either AC grid or DC photo-voltaic array. With only DC input, the drive starts running a connected pump whenever there is enough solar radiation available to generate electricity required to run the pump smoothly with controlled acceleration and deceleration even when there are sudden changes in DC voltage due to cloud passing. This helps to avoid motor and pump damage.

Built-in MPPT logic monitors available DC power and allows to avoid multiple restarts of pump motor during early morning and late evening time when PV array is the only source of power to the drive.

During an ON command to the drive, the flow rate depends on the power availability as explained in the below graph.

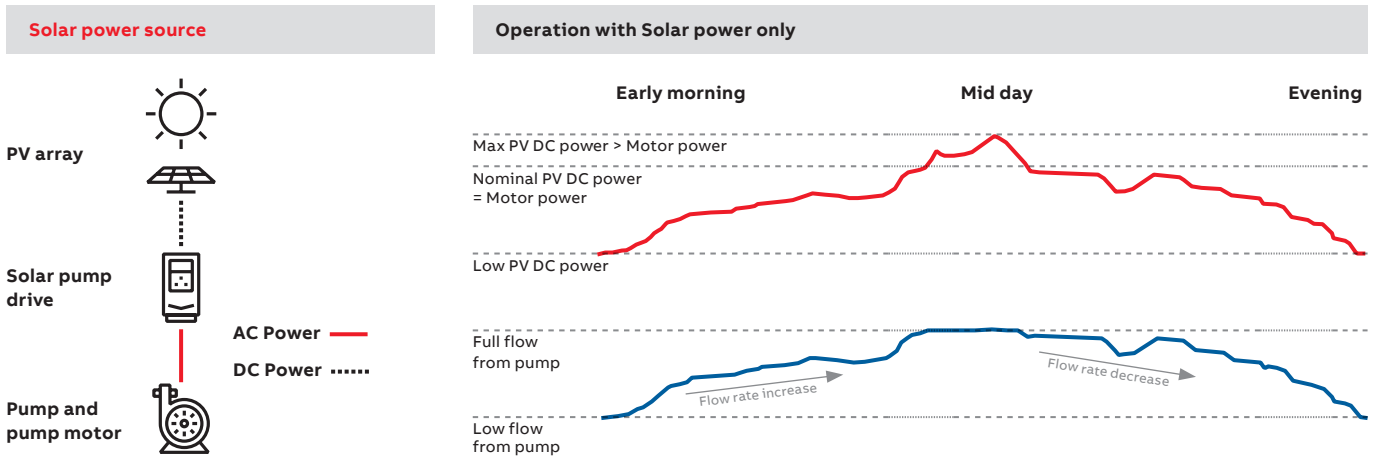

To get maximum water flow throughout the day and reduce grid power consumption, both grid and PV can be connected. During night time drive can run pump motor on grid power.

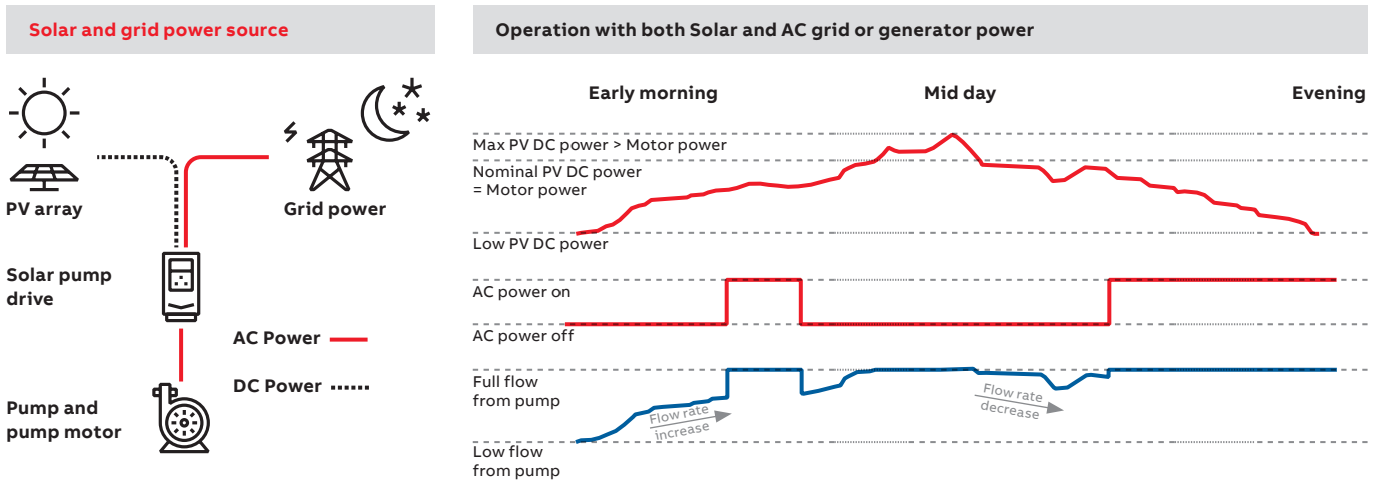

Environmentally friendly solution



Save energy costs and maximize productivity
By harnessing the sun's power, the ABB solar pump drives provide environmentally friendly pumping without any CO₂ emissions. Emission-free and maximum water flow during the daytime is ensured by running the pumps on Solar PV panels. For the nighttime and cloudy day operation, the drive can be connected to an AC power source along with a DC PV source to maximize productivity.



Reduce maintenance costs
The drives can be connected with remote monitoring units, reducing maintenance trips to the site.



ACQ80 solar pump drive by ABB was awarded the "Solar Impulse Efficient Solution" label following an assessment performed by experts from Solar Impulse and their associated organizations. It thereby joins the Solar Impulse Foundation's #1000solutions challenge list of solutions which make an impact on the environment profitably and sustainably.

Reduce operational risk

Embedded pump-specific features such as dry run detection and pump cleaning protects the pump and keeps the process running.



ABB AC drives comply with the EU Ecodesign requirements

The Ecodesign regulation (EU) 2019/1781 is the legislative framework, that sets minimum energy efficiency requirements for low voltage induction motors and variable speed drives. AC drives and power drive systems are classified according to their power losses. From July 2021, the minimum requirement for non-regenerative AC drives in EU is IE2.

ABB’s AC drives (micro and machinery, general purpose, industrial and industry-specific drives) comply with the strictest requirements of the standard for energy efficiency and are classified as IE2.

Energy efficiency classes for a Complete Drive Module (CDM)

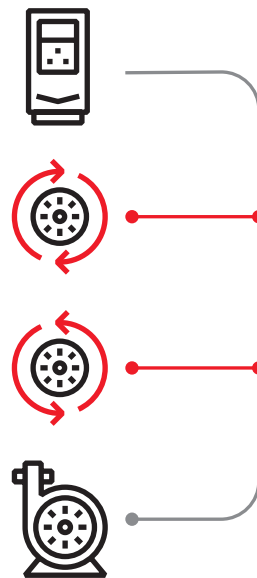
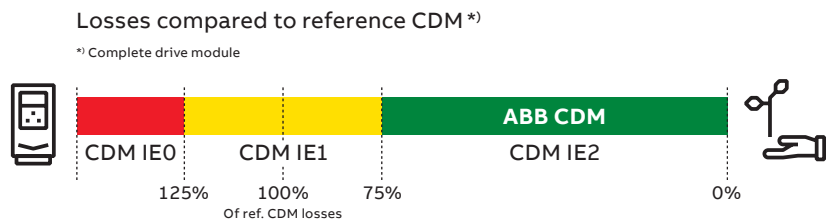

Markings on the ABB LV AC drives

Unique identifier QR code to Ecodesign information

IE class and % loss of rated apparent power 50 Hz, 400 V

IE2 (90;100) 2,3 %

Unique QR codes are located on the rating plate and/or the front side of the drive.

ABB EcoDesign web-based tool



- Calculates absolute and relative losses and efficiency data at standard and user-defined operating points according to EU regulation 2019/1781 for complete drive module (CDM), LV motors with VSD supply, and power drive system (PDS)
- Losses and efficiency data at operating points in graphical and table format
- Printable efficiency report with possibility to customize title and additional details
- Report can be converted to PDF or CSV format and shared via email

The regulation was implemented in two steps:

- Step 1: July 1, 2021**
- Power range: from 0.12 to 1000 kW
 - 3-phase LV AC drives with diode rectifier
 - Drive manufacturers must declare power losses in percentage of the rated apparent output power at 8 different operating points as well as standby losses. The international IE level is given at the nominal point. Drives fulfilling the requirements will be CE marked.

Out of scope of the regulation:

- All drives without CE marking
- Following low voltage AC drives: regenerative drives, low-harmonic drives (THD < 10%), multiple AC-output drives and single-phase drives.
- Medium voltage drives, DC drives and traction drives
- Drive cabinets with already conformity assessed modules

Step 2: July 1, 2023
No changes for AC drives

ACQ80-04 standard interface

ACQ80 drives offer a wide range of standard interfaces. In addition, the drive has one slot for either an I/O module or a fieldbus module.



The standard delivery of the ACQ80 includes the I/O module. If a fieldbus adapter is needed instead, it should be ordered with a corresponding plus code.

Default factory I/O connection diagram

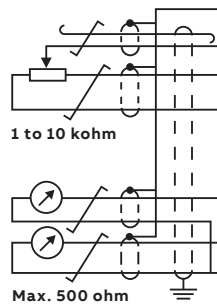

Terminal	Meaning	Default ABB standard macro connections
X1 Reference voltage and analog inputs and outputs.		
1	SCR	Signal cable shield (screen)
2	AI1	Not configured
3	AGND	Analog input circuit common
4	+10 V	Reference voltage 10 V DC
5	AI2	Not configured
6	AGND	Analog input circuit common
7	AO1	Output frequency: 0...20 mA
8	AO2	Motor current
9	AGND	Analog output circuit common
X2, X3 Aux. voltage output and programmable digital inputs		
10	+24 V	Auxiliary voltage output +24 V DC, max. 250 mA ●
11	DGND	Auxiliary voltage output common ●
12	DCOM	Digital input common for all ●
13	DI1	Start (0)/Stop (1) ●
14	DI2	Not configured ●
15	DI3	Not configured
16	DI4	Not configured
17	DI5	Not configured
18	DI6	Not configured
X6, X7, X8 Relay outputs		
19	RO1C	Ready run 250 V AC/30 V DC 2 A ●
20	RO1A	
21	RO1B	
22	RO2C	Running 250 V AC/30 V DC 2 A ●
23	RO2A	
24	RO2B	
25	RO3C	Fault (-1) 250 V AC/30 V DC 2 A ●
26	RO3A	
27	RO3B	
X5 EIA-485 Modbus RTU		
29	B+	Embedded Modbus RTU (EIA-485)
30	A-	
31	DGND	
Frames R0-R2		
S100	TERM&BIAS	Termination resistor and bias resistor switch
Frame R3		
S100	TERM	Termination resistor switch
S200	BIAS	Bias resistor switch
X4 Safe torque off		
34	SGND	●
35	IN1	Safe Torque Off (STO). Factory connection. ●
36	IN2	Both circuits must be closed for the drive to start. ●
37	OUT1	●
X11 Redundant auxiliary voltage output (frames R0-R2 only)		
42	+24 V	Aux. voltage output +24 V DC, max. 250 mA
43	DGND	Aux. voltage output common
44	DCOM	Digital input common for all

● = Refers to terminals in the base unit. The other terminals are in the RIIO-01/I/O extension module (part of standard delivery).

ACQ80-01 and ACQ80-07 standard interface

ACQ80-01 and -07 drives offer a wide range of standard interfaces. In addition, the drive has two option slots that can be used for extensions, including fieldbus adapters and input/output extension modules that allow an external +24 V supply with frame sizes R1 to R5. For frames R6-R11 external +24 V terminals are already integrated on the control board. For further information, please see the ACQ80 user manual.

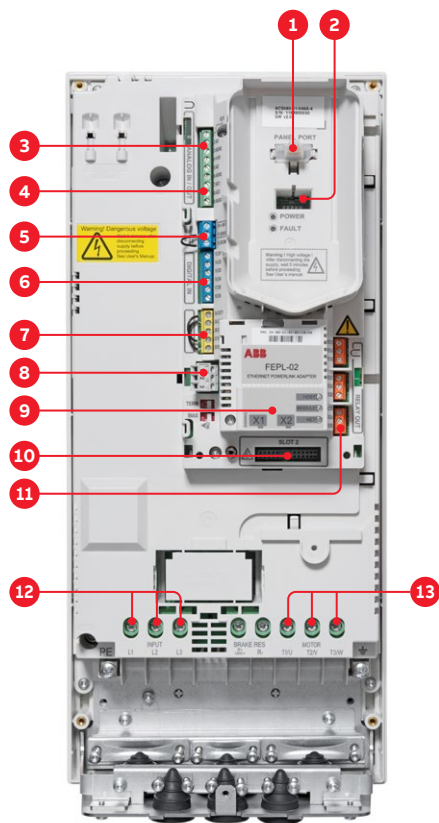

1. Panel port (PC tools, control panel)
2. ABB drive customizer port for programming the drive without mains
3. Analog inputs (2 × AI)
4. Analog outputs (2 × AO)
5. 24 V AC/DC output
6. Digital inputs (6 × DI)
7. Safe Torque Off (STO)
8. Embedded fieldbus
9. Communication options (fieldbuses)
10. I/O extensions
11. Relay outputs (3 × RO)
12. Mains connection
13. Motor connection

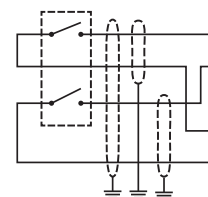
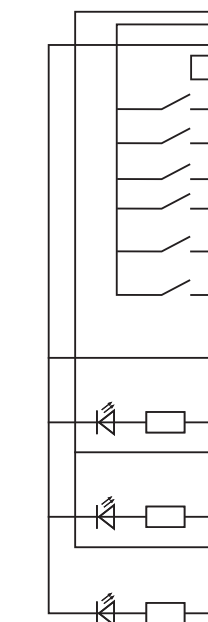
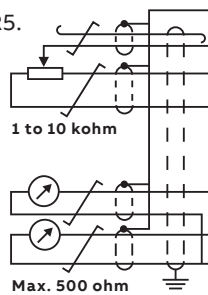

Default factory I/O connection diagram: Macro ABB standard

Terminal	Meaning	Default macro connections
X1 Reference voltage and analog inputs and outputs		
1	SCR	Signal cable shield (screen)
2	AI1	External frequency reference 1: 0 to 10 V
3	AGND	Analog input circuit common
4	+10 V	Output reference voltage 10 V DC
5	AI2	Not used
6	AGND	Analog input circuit common
7	AO1	Output frequency: 0 to 20 mA
8	AO2	Output current: 0 to 20 mA
9	AGND	Analog output circuit common
X2 & X3 Aux. voltage output and programmable digital inputs		
10	+24 V	Auxiliary voltage output +24 V DC
11	DGND	Auxiliary voltage output common
12	DCOM	Digital input common for all DI
13	DI1	Start/Stop: Activate to start
14	DI2	Fwd/Rev: Activate to reverse rotation direction
15	DI3	Constant speed selection
16	DI4	Constant speed selection
17	DI5	Ramp pair selection: Activate to select second pair
18	DI6	Not used
X6, X7, X8 Relay outputs		
19	RO1C	Ready
20	RO1A	250 V AC/30 V DC 2 A
21	RO1B	
22	RO2C	Running
23	RO2A	250 V AC/30 V DC 2 A
24	RO2B	
25	RO3C	Fault (-1)
26	RO3A	250 V AC/30 V DC 2 A
27	RO3B	
X5 EIA-485 Modbus RTU		
29	B+	Built-in Modbus RTU fieldbus interface
30	A-	
31	DGND	
X4 Safe torque off		
34	OUT1	Safe Torque Off (STO). Both circuits must be closed for the drive to start. The circuits are closed with jumper wires in the standard delivery.
35	OUT2	
36	SGND	
37	IN1	
38	IN2	
X10*) 24 V AC/DC		
40	24 V	AC/DC-in. Ext. 24 V AC/DC input to power up the control unit when the main supply is disconnected
41	24 V	AC/DC+in.

*) The terminals 40-41 are integrated only in the frame sizes R6-R11. For the frame sizes R1-R5 I/O options (+L) are needed.

How to select a drive

This is how you build up your own ordering code using the type designation key.

Start by identifying your supply voltage.
This tells you what rating table to use.
See pages 14 and 15.

Select your drive's order code from the rating table based on your motor's nominal power rating.

ABB SOLAR PUMP DRIVES ACQ80, 0.75 to 200 kW

Ratings, types and voltages

Drive type: ACQ80-04 (3 phase supply, voltage range 380-480 V) PMS (ACQ80-04) and PMS (ACQ80-04)

Drive type	Frame size	Typical motor power (kW)	Input DC current (A)	Max. output current (A)	Max. output power (kW)
ACQ80-04-000W-0-0	80	0.75	1	0.75	0.75
ACQ80-04-000W-0-1	80	1.1	1.5	1.1	1.1
ACQ80-04-000W-0-2	80	1.5	2	1.5	1.5
ACQ80-04-000W-0-3	80	2.2	3	2.2	2.2
ACQ80-04-000W-0-4	80	3	4	3	3
ACQ80-04-000W-0-5	80	4	5	4	4
ACQ80-04-000W-0-6	80	5.5	7.5	5.5	5.5
ACQ80-04-000W-0-7	80	7.5	10	7.5	7.5
ACQ80-04-000W-0-8	80	11	15	11	11
ACQ80-04-000W-0-9	80	15	20	15	15
ACQ80-04-000W-1-0	80	18.5	25	18.5	18.5
ACQ80-04-000W-1-1	80	22	30	22	22
ACQ80-04-000W-1-2	80	30	40	30	30
ACQ80-04-000W-1-3	80	37	50	37	37
ACQ80-04-000W-1-4	80	45	60	45	45
ACQ80-04-000W-1-5	80	55	75	55	55
ACQ80-04-000W-1-6	80	75	100	75	75
ACQ80-04-000W-1-7	80	110	148	110	110
ACQ80-04-000W-1-8	80	150	207	150	150
ACQ80-04-000W-1-9	80	180	255	180	180
ACQ80-04-000W-2-0	80	220	303	220	220
ACQ80-04-000W-2-1	80	250	342	250	250

Drive type: ACQ80-04 (3 phase supply, voltage range 380-480 V) PMS (ACQ80-04) and PMS (ACQ80-04)

Drive type	Frame size	Typical motor power (kW)	Input DC current (A)	Max. output current (A)	Max. output power (kW)
ACQ80-04-000W-0-0	80	0.75	1	0.75	0.75
ACQ80-04-000W-0-1	80	1.1	1.5	1.1	1.1
ACQ80-04-000W-0-2	80	1.5	2	1.5	1.5
ACQ80-04-000W-0-3	80	2.2	3	2.2	2.2
ACQ80-04-000W-0-4	80	3	4	3	3
ACQ80-04-000W-0-5	80	4	5	4	4
ACQ80-04-000W-0-6	80	5.5	7.5	5.5	5.5
ACQ80-04-000W-0-7	80	7.5	10	7.5	7.5
ACQ80-04-000W-0-8	80	11	15	11	11
ACQ80-04-000W-0-9	80	15	20	15	15
ACQ80-04-000W-1-0	80	18.5	25	18.5	18.5
ACQ80-04-000W-1-1	80	22	30	22	22
ACQ80-04-000W-1-2	80	30	40	30	30
ACQ80-04-000W-1-3	80	37	50	37	37
ACQ80-04-000W-1-4	80	45	60	45	45
ACQ80-04-000W-1-5	80	55	75	55	55
ACQ80-04-000W-1-6	80	75	100	75	75
ACQ80-04-000W-1-7	80	110	148	110	110
ACQ80-04-000W-1-8	80	150	207	150	150
ACQ80-04-000W-1-9	80	180	255	180	180
ACQ80-04-000W-2-0	80	220	303	220	220
ACQ80-04-000W-2-1	80	250	342	250	250



Choose your motor's power and current rating from the ratings tables on pages 14 and 15.

ABB SOLAR PUMP DRIVES ACQ80, 0.75 to 200 kW

Ratings, types and voltages

Drive type: ACQ80-04 (3 phase supply, voltage range 380-480 V) PMS (ACQ80-04) and PMS (ACQ80-04)

Drive type	Frame size	Typical motor power (kW)	Input DC current (A)	Max. output current (A)	Max. output power (kW)
ACQ80-04-000W-0-0	80	0.75	1	0.75	0.75
ACQ80-04-000W-0-1	80	1.1	1.5	1.1	1.1
ACQ80-04-000W-0-2	80	1.5	2	1.5	1.5
ACQ80-04-000W-0-3	80	2.2	3	2.2	2.2
ACQ80-04-000W-0-4	80	3	4	3	3
ACQ80-04-000W-0-5	80	4	5	4	4
ACQ80-04-000W-0-6	80	5.5	7.5	5.5	5.5
ACQ80-04-000W-0-7	80	7.5	10	7.5	7.5
ACQ80-04-000W-0-8	80	11	15	11	11
ACQ80-04-000W-0-9	80	15	20	15	15
ACQ80-04-000W-1-0	80	18.5	25	18.5	18.5
ACQ80-04-000W-1-1	80	22	30	22	22
ACQ80-04-000W-1-2	80	30	40	30	30
ACQ80-04-000W-1-3	80	37	50	37	37
ACQ80-04-000W-1-4	80	45	60	45	45
ACQ80-04-000W-1-5	80	55	75	55	55
ACQ80-04-000W-1-6	80	75	100	75	75
ACQ80-04-000W-1-7	80	110	148	110	110
ACQ80-04-000W-1-8	80	150	207	150	150
ACQ80-04-000W-1-9	80	180	255	180	180
ACQ80-04-000W-2-0	80	220	303	220	220
ACQ80-04-000W-2-1	80	250	342	250	250

Drive type: ACQ80-04 (3 phase supply, voltage range 380-480 V) PMS (ACQ80-04) and PMS (ACQ80-04)

Drive type	Frame size	Typical motor power (kW)	Input DC current (A)	Max. output current (A)	Max. output power (kW)
ACQ80-04-000W-0-0	80	0.75	1	0.75	0.75
ACQ80-04-000W-0-1	80	1.1	1.5	1.1	1.1
ACQ80-04-000W-0-2	80	1.5	2	1.5	1.5
ACQ80-04-000W-0-3	80	2.2	3	2.2	2.2
ACQ80-04-000W-0-4	80	3	4	3	3
ACQ80-04-000W-0-5	80	4	5	4	4
ACQ80-04-000W-0-6	80	5.5	7.5	5.5	5.5
ACQ80-04-000W-0-7	80	7.5	10	7.5	7.5
ACQ80-04-000W-0-8	80	11	15	11	11
ACQ80-04-000W-0-9	80	15	20	15	15
ACQ80-04-000W-1-0	80	18.5	25	18.5	18.5
ACQ80-04-000W-1-1	80	22	30	22	22
ACQ80-04-000W-1-2	80	30	40	30	30
ACQ80-04-000W-1-3	80	37	50	37	37
ACQ80-04-000W-1-4	80	45	60	45	45
ACQ80-04-000W-1-5	80	55	75	55	55
ACQ80-04-000W-1-6	80	75	100	75	75
ACQ80-04-000W-1-7	80	110	148	110	110
ACQ80-04-000W-1-8	80	150	207	150	150
ACQ80-04-000W-1-9	80	180	255	180	180
ACQ80-04-000W-2-0	80	220	303	220	220
ACQ80-04-000W-2-1	80	250	342	250	250

Choose your options on pages 25, 28 and 29 and add the option codes to the drive's order code. Remember to use a "+" mark before each option code.



ABB SOLAR PUMP DRIVES ACQ80, 0.75 to 200 kW

Options

Option code	ABB code	Description	Type designation
L504	3A82000001970	Reduction of input current (ACQ80-04) to 100% of the rated value (ACQ80-04) (ACQ80-04) (ACQ80-04)	BD-04
L515	3A82000001985	Reduction of input current (ACQ80-04) to 100% of the rated value (ACQ80-04) (ACQ80-04) (ACQ80-04)	BD-04
L514	3A82000001984	Reduction of input current (ACQ80-04) to 100% of the rated value (ACQ80-04) (ACQ80-04) (ACQ80-04)	BD-04
L513	3A82000001983	Reduction of input current (ACQ80-04) to 100% of the rated value (ACQ80-04) (ACQ80-04) (ACQ80-04)	BD-04
L512	3A82000001982	Reduction of input current (ACQ80-04) to 100% of the rated value (ACQ80-04) (ACQ80-04) (ACQ80-04)	BD-04
L511	3A82000001981	Reduction of input current (ACQ80-04) to 100% of the rated value (ACQ80-04) (ACQ80-04) (ACQ80-04)	BD-04

ACQ80-04 (3 phase supply, voltage range 380-480 V) PMS (ACQ80-04) and PMS (ACQ80-04)

Option code	ABB code	Description	Type designation
L504	3A82000001970	Reduction of input current (ACQ80-04) to 100% of the rated value (ACQ80-04) (ACQ80-04) (ACQ80-04)	BD-04
L515	3A82000001985	Reduction of input current (ACQ80-04) to 100% of the rated value (ACQ80-04) (ACQ80-04) (ACQ80-04)	BD-04
L514	3A82000001984	Reduction of input current (ACQ80-04) to 100% of the rated value (ACQ80-04) (ACQ80-04) (ACQ80-04)	BD-04
L513	3A82000001983	Reduction of input current (ACQ80-04) to 100% of the rated value (ACQ80-04) (ACQ80-04) (ACQ80-04)	BD-04
L512	3A82000001982	Reduction of input current (ACQ80-04) to 100% of the rated value (ACQ80-04) (ACQ80-04) (ACQ80-04)	BD-04
L511	3A82000001981	Reduction of input current (ACQ80-04) to 100% of the rated value (ACQ80-04) (ACQ80-04) (ACQ80-04)	BD-04

ACQ80-04 (3 phase supply, voltage range 380-480 V) PMS (ACQ80-04) and PMS (ACQ80-04)

Option code	ABB code	Description	Type designation
L504	3A82000001970	Reduction of input current (ACQ80-04) to 100% of the rated value (ACQ80-04) (ACQ80-04) (ACQ80-04)	BD-04
L515	3A82000001985	Reduction of input current (ACQ80-04) to 100% of the rated value (ACQ80-04) (ACQ80-04) (ACQ80-04)	BD-04
L514	3A82000001984	Reduction of input current (ACQ80-04) to 100% of the rated value (ACQ80-04) (ACQ80-04) (ACQ80-04)	BD-04
L513	3A82000001983	Reduction of input current (ACQ80-04) to 100% of the rated value (ACQ80-04) (ACQ80-04) (ACQ80-04)	BD-04
L512	3A82000001982	Reduction of input current (ACQ80-04) to 100% of the rated value (ACQ80-04) (ACQ80-04) (ACQ80-04)	BD-04
L511	3A82000001981	Reduction of input current (ACQ80-04) to 100% of the rated value (ACQ80-04) (ACQ80-04) (ACQ80-04)	BD-04

Type designation example:



- Product series ACQ80
- Type: 0 = standard
- Construction: 1 = wall mounted, 4 = drive module, 7 = cabinet-built
- Rating
- Voltage: 4 = 3 ph 400 V
- Options

Technical data

Mains connection	
Voltage and power range	AC: 3-phase, 380 to 480 V, +10%/-15% DC: ACQ80-04: 225 to 800 V DC ACQ80-01, ACQ80-07 (R4-R5): 300 to 800 V DC ACQ80-01, ACQ80-07 (R6-R9): 390 to 800 V DC *) ACQ80-04, IP20: 0.75 to 22 kW (1-30 HP) **) ACQ80-01, IP21: 30 to 200 kW (40-268 HP) **) ACQ80-01, IP55: 30 to 200 kW (40-268 HP) **) ACQ80-07, IP42, IP54: 75 to 200 kW (101-268 HP) **)
Power factor	$\cos \varphi = 0.98$
Efficiency (at nominal power)	98%
Efficiency class (IEC 61800-9-2)	IE2
Frequency	47.5 to 63 Hz
Motor connection	
Voltage	0 to U_n , 3-phase
Frequency	ACQ80-04: 0 to 599 Hz ACQ80-01 and ACQ80-07: 0 to 500 Hz
Motor control	Scalar and vector control
Supported motor types	Asynchronous motor, permanent magnet motor, permanent magnet assisted synchronous reluctance motor
Product compliance	
CE Low Voltage Directive 2014/34/EU, EN 61800-5-1: 2007 Machinery Directive 2006/42/EC, EN 61800-5-2: 2007 EMC Directive 2014/30/EU, EN 61800-3: 2004 + A1: 2012 RoHS directive 2011/65/EU Quality assurance system ISO 9001 Environmental system ISO 14001 Waste electrical and electronic equipment directive (WEEE) 2002/96/EC RoHS directive 2011/65/EU TÜV certification for functional safety	
Inputs and outputs (standard configuration)	
2 analog inputs	Selection of Current/Voltage input mode is user programmable.
Voltage signal	0 (2) to 10 V, $R_{in} > 200 \text{ k}\Omega$
Current signal	0 (4) to 20 mA, $R_{in} = 137 \Omega$
Potentiometer reference value	10 V $\pm 1\%$ max. 10 mA
2 analog outputs	AO1 is user programmable for current or voltage. AO2 current
Voltage signal	0 to 10 V, $R_{load} < 500 \text{ k}\Omega$
Internal auxiliary voltage	24 V DC $\pm 10\%$, max. 200 mA
6 digital inputs	12 to 24 V DC, 24 V AC. PNP or NPN connection (5 DIs with NPN connection).
3 relay outputs	Maximum switching voltage 250 V AC/30 V DC Maximum continuous current 2 A rms
Supported thermistors	Any of the analog inputs are configurable for PTC. Both analog outputs can be used to feed the PT100, PT1000, KTY83, KTY84 or Ni1000 sensors.

Communication	
Protocol as standard (EIA-485): Modbus RTU. Protocols available as option: DeviceNet, PROFIBUS DP, CANopen, EtherCAT, Modbus/TCP, PROFINET IO.	
EMC according to EN 61800-3: 2004 + A1: 2012	
ACQ80-04: Class C2 as standard ACQ80-01: Class C2 as standard ACQ80-07: Class C2 as standard for powers 75 kW to 200 kW	
Functional safety	
STO according to EN 61800-5-2:2016, IEC 61508 Parts 1-2:2010, ISO 13849-1:2015, ISO 13849-2:2012, IEC 62061:2015 SIL 3/PL e	
Environmental limits	
Transportation and storage temperature	-40 to +70 °C
Operation temperature	ACQ80-04: -10 to +60 °C no frost allowed, +50 to +60 °C with derating ACQ80-01: -15 to +50 °C no frost allowed, +40 to +50 °C with derating ACQ80-07: 0 to +40 °C no frost allowed, +40 to +50 °C with derating
Cooling method	Air-cooled, dry clean air
Altitude	0 to 1,000 m without derating 1,000 to 2,000 m with derating of 1%/100 m Above 2,000 m contact your local ABB representative
Relative humidity	5 to 95%, no condensation allowed
Degree of protection	ACQ80-04: IP20 ACQ80-01: IP21 as standard, IP55 as option ACQ80-07: IP54 as standard, IP42 as option
Contamination levels	No conductive dust allowed
Storage	IEC 60721-3-1. Class 1C2 (chemical gases). Class 1S2 (solid particles) ***)
Transportation	IEC 60721-3-2. Class 2C2 (chemical gases) Class 2S2 (solid particles) *)
Operation	IEC 60721-3-3. Class 3C2 (chemical gases). Class 3S2 (solid particles) ***)

*) ACQ80-01 (R6-R9) drives need external charging circuit, on the DC bus. The necessary details are mentioned in the hardware manual, document code 3AXD50001017101.

**) Note: check the power range available for your region with your local ABB representative.

***) C = chemically active substances,
S = mechanically active substances

Ratings, types and voltages

Drive modules, ACQ80-04 (3-phase supply voltage range 380-480 V) IP20 (ACQ80-04) and IP21 (ACQ80-01)							
Drive type	Frame size	Typical motor power		Input DC current	Nominal ratings	Light-duty use	Max. output current
		P_N (kW)	P_N (hp)	I_{DC} (A)	I_N (A)	I_{LD} (A)	I_{max} (A)
ACQ80-04-0KW75-4	R0	0.75	1	3.18	2.6	2.6	3.2
ACQ80-04-01KW1-4	R0	1.1	1.5	4.04	3.3	3.3	4.7
ACQ80-04-01KW5-4	R0	1.5	2	4.90	4	4	5.9
ACQ80-04-02KW2-4	R0	2.2	3	6.85	5.6	5.6	7.2
ACQ80-04-03KW0-4	R0	3	4	8.81	7.2	7.2	10.1
ACQ80-04-04KW0-4	R0	4	5	11.50	9.4	9.4	13
ACQ80-04-05KW5-4	R1	5.5	7.5	15.42	12.6	12.6	16.9
ACQ80-04-07KW5-4	R2	7.5	10	20.80	17	17	22.7
ACQ80-04-011KW-4	R2	11	15	30.60	25	25	30.6
ACQ80-04-015KW-4	R3	15	20	40.39	32	32	45
ACQ80-04-18KW5-4	R3	18.5	25	47.74	38	38	57.6
ACQ80-04-022KW-4	R3	22	30	61.20	50	50	81
ACQ80-01-030KW-4	R4	30	40	75.89	62	58	81
ACQ80-01-037KW-4	R4	37	50	89.35	73	68	110
ACQ80-01-045KW-4	R4	45	60	108.94	89	83	130
ACQ80-01-055KW-4	R5	55	74	129.74	106	100	157
ACQ80-01-075KW-4	R6	75	101	177.48	145	138	178
ACQ80-01-090KW-4	R7	90	121	206.85	169	161	247
ACQ80-01-110KW-4	R7	110	148	252.14	206	196	287
ACQ80-01-132KW-4	R8	132	177	301.10	246	234	350
ACQ80-01-160KW-4	R8	160	215	358.63	293	287	418
ACQ80-01-200KW-4	R9	200	268	444.31	363	345	498

Drive modules, ACQ80-01 (3-phase supply voltage range 380-480 V) IP55							
Drive type	Frame size	Typical motor power		Input DC current	Nominal ratings	Light-duty use	Max. output current
		P_N (kW)	P_N (hp)	I_{DC} (A)	I_N (A)	I_{LD} (A)	I_{max} (A)
ACQ80-01-030KW-4+B056	R4	30	40	75.89	62	58	81
ACQ80-01-037KW-4+B056	R4	37	50	89.35	73	68	110
ACQ80-01-045KW-4+B056	R4	45	60	108.94	89	83	130
ACQ80-01-055KW-4+B056	R5	55	74	129.74	106	100	157
ACQ80-01-075KW-4+B056	R6	75	101	177.47	145	138	178
ACQ80-01-090KW-4+B056	R7	90	121	206.85	169	161	247
ACQ80-01-110KW-4+B056	R7	110	148	252.14	206	196	287
ACQ80-01-132KW-4+B056	R8	132	177	301.10	246	234	350
ACQ80-01-160KW-4+B056	R8	160	215	358.62	293	287	418
ACQ80-01-200KW-4+B056	R9	200	268	444.31	363	345	498

Cabinet-built drives, ACQ80-07 (3-phase supply voltage range 380-480 V) IP42, IP54							
Drive type	Frame size	Typical motor power		Input DC current	Nominal ratings	Light-duty use	Max. output current
		P_N (kW)	P_N (hp)	I_{DC} (A)	I_N (A)	I_{LD} (A)	I_{max} (A)
ACQ80-07-075KW-4	R6	75	101	177.47	145	138	178
ACQ80-07-090KW-4	R7	90	121	206.85	169	161	247
ACQ80-07-110KW-4	R7	110	148	252.14	206	196	287
ACQ80-07-132KW-4	R8	132	177	301.10	246	234	350
ACQ80-07-160KW-4	R8	160	215	358.62	293	287	418
ACQ80-07-200KW-4	R9	200	268	444.31	363	345	498

Ratings

I_{max} (A)	Maximum output current. Available for 2 seconds at start.
P_N (kW)/(hp)	Typical motor power
I_N (A)	Rated current available continuously without overloadability at 40 °C.
I_{LD} (A)	Continuous current allowing 110% I_{LD} for 1 minute every 10 minutes at 40 °C.

Dimensions

ACQ80-04 IP20, standard

Frames	Height		Width		Depth		Weight (kg)
	(mm)	(in)	(mm)	(in)	(mm)	(in)	
R0	223	8.78	73	2.87	207.1	8.15	1.7
R1	223	8.78	96.6	3.8	207.1	8.15	2.3
R2	220	8.66	171.7	6.76	207.1	8.15	3.6
R3	240	9.45	260	10.24	212.1	8.35	5.6



ACQ80-01 IP21, standard

Frames	Height		Width		Depth		Weight (kg)
	(mm)	(in)	(mm)	(in)	(mm)	(in)	
R4	636	25	203	8	257	10.2	19
R5	732	28.8	203	8	295	11.6	28.3
R6	727	28.6	252	9.9	369	14.5	42.4
R7	880	34.6	284	11.2	370	14.6	54
R8	965	38	300	11.8	393	15.5	60
R9	955	37.6	380	15	418	16.5	97



ACQ80-04 IP55, standard

Frames	Height		Width		Depth		Weight (kg)
	(mm)	(in)	(mm)	(in)	(mm)	(in)	
R4	636	25	203	8	265	10.2	23.3
R5	732	28.8	203	8	320	12.6	33
R6	727	28.6	252	9.9	380	15	43
R7	880	34.6	284	11.2	381	15	56
R8	965	38	300	11.8	452	17.8	77
R9	955	37.6	380	15	477	18.8	103



ACQ80-07 IP42, standard

Frames	Height		Width		Depth		Weight (kg)
	(mm)	(in)	(mm)	(in)	(mm)	(in)	
R6	2145	84.4	430	16.9	673	26.5	210
R7	2145	84.4	430	16.9	673	26.5	220
R8	2145	84.4	530	20.9	673	26.5	225
R9	2145	84.4	530	20.9	673	26.5	275

ACQ80-07 IP54, standard

Frames	Height		Width		Depth		Weight (kg)
	(mm)	(in)	(mm)	(in)	(mm)	(in)	
R6	2145	84.4	430	16.9	673	26.5	210
R7	2145	84.4	430	16.9	673	26.5	220
R8	2145	84.4	530	20.9	673	26.5	225
R9	2145	84.4	530	20.9	673	26.5	275



Pre-charging circuits

An essential component for ACQ80-01 R6-R9 frames

If ACQ80-01 frames R6-R9 (75 to 200 kW) are expected to start only by DC source from the PV cells or are expected to operate on Intelligent Hybrid mode, it is essential to incorporate an external pre-charging circuit on the DC bus. The existing built-in Pre-charging Circuit into ACQ80-01 for frames (R6-R9) can be used if the drives are started only on the AC supply. Detailed specifications and installation guidelines for the pre-charging circuit can be found in the hardware manual, document code [3AXD50001017101](#).

Working Principle of a Pre-charging Circuit

When a VFD is powered on, the DC bus capacitors initially appear as short circuit, leading to a high inrush current. This surge can damage the capacitors and other components. The pre-charging circuit mitigates this by gradually charging the capacitors to the operating voltage.

Components

Resistor. Limits the initial current flow.

Contactor/Relay. Bypasses the resistor once the capacitors are charged.

Control Circuit. Manages the timing and operation of the resistor and contactor.

Solar UPS / 230V AC supply. To control the Aux. contactors.

Operation Steps

Initial Power-Up. When the VFD is first powered on, the control circuit closes the pre-charge contactor, allowing current to flow through the resistor.

Gradual Charging. The resistor limits the current, allowing the DC bus capacitors to charge slowly to the source voltage.

Bypass Phase. Once the capacitors are nearly fully charged, the control circuit opens the pre-charge contactor and closes the main contactor, bypassing the resistor and allowing normal operation.

Connecting the power cables

1. Reverse polarity diodes. For more information, see the hardware manual, document code [3AXD50001017101](#), section Reverse polarity diodes (page 158).
2. EMI filter is optional but is mandatory for EN62920 standard compliance which is required in Europe. For more information, see the hardware manual, document code [3AXD50001017101](#), section Reverse polarity diodes (page 158). To comply to EN62920, refer to EMI filter layout diagram in Dimension drawings (page 181).
3. Ground connection should be common for MOV, drive, and pump.
4. Frames R6...R9 only: Initially the charging happens through the resistance and once predefine voltage charging is completed then the contactor will be closed.

Note: ACQ80 is intended to be used for speed control of 3-phase AC pump motors and is powered from either AC Grid or DC photo-voltaic array. ABB recommends not to use it as an island grid forming inverter or to supply generic single phase or 3-phase loads, other than 3-phase AC pump motors.

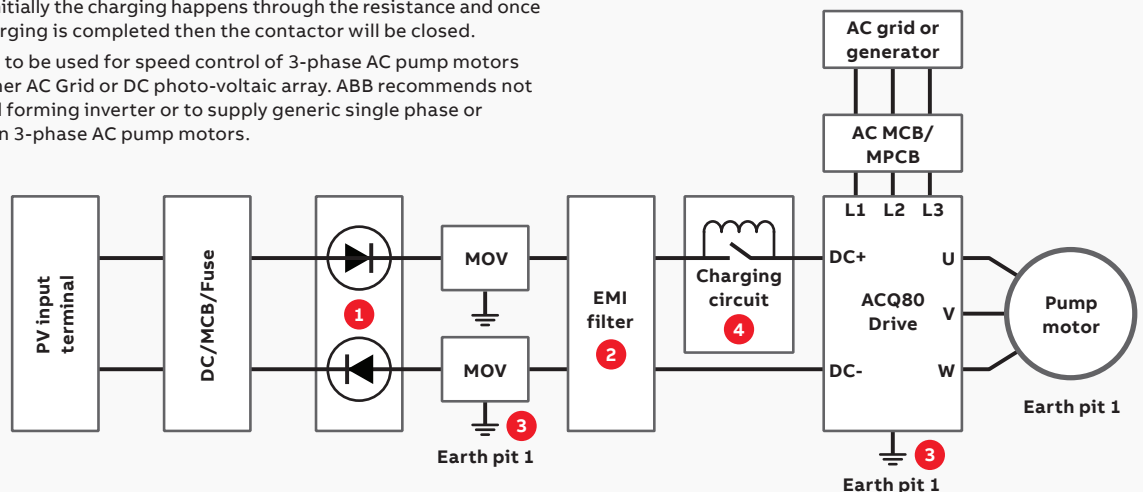

Cooling and fuses

Cooling

ACQ80 drives are fitted with variable-speed cooling air fans. The cooling air must be free from corrosive materials and not exceed the maximum ambient temperature of 50 °C (60 °C with derating) and 40 °C (50 °C with derating) for ACQ80-04 and ACQ80-01 respectively. The speed-controlled fans cool the drive only when needed, which reduces overall noise level and energy consumption.

Fuse connections

Standard fuses can be used with ABB general purpose drives. For input fuses, see the tables below.

Drive modules, ACQ80 (3-phase supply voltage range 380-480 V) IP20 (ACQ80-04) and IP21 (ACQ80-01)									
Drive type	Frame size	Cooling air flow 380 to 480 V units					Recommended input protection fuses 380 to 480 V units ***)		
		Heat dissipation *)		Airflow		Max. noise level **)	IEC fuses		
		(W)	(BTU/h)	(m ³ /h)	(ft ³ /min)		(A)	Fuse type	
ACQ80-04-0KW75-4	R0	55	189	57	33	63	6	gG	
ACQ80-04-01KW1-4	R0	62	213	57	33	63	6	gG	
ACQ80-04-01KW5-4	R0	70	240	57	33	63	10	gG	
ACQ80-04-02KW2-4	R0	88	302	57	33	63	10	gG	
ACQ80-04-03KW0-4	R0	108	368	57	33	63	16	gG	
ACQ80-04-04KW0-4	R0	135	461	57	33	63	16	gG	
ACQ80-04-05KW5-4	R1	178	609	63	37	59	25	gG	
ACQ80-04-07KW5-4	R2	230	784	128	75	66	32	gG	
ACQ80-04-011KW-4	R2	344	1174	128	75	66	50	gG	
ACQ80-04-015KW-4	R3	465	1587	150	88	69	63	gG	
ACQ80-04-18KW5-4	R3	566	1934	150	88	69	80	gG	
ACQ80-04-022KW-4	R3	668	2281	150	88	69	100	gG	
ACQ80-01-030kW-4	R4	803	2740	150	88	70	80	gG	
ACQ80-01-037kW-4	R4	882	3010	150	88	70	100	gG	
ACQ80-01-045kW-4	R4	1059	3613	159	94	70	100	gG	
ACQ80-01-055kW-4	R5	1290	4402	139	82	63	125	gG	
ACQ80-01-075KW-4	R6	1960	6688	435	256	67	160	gG	
ACQ80-01-090KW-4	R7	2120	6896	450	265	67	250	gG	
ACQ80-01-110KW-4	R7	2785	9503	450	265	67	315	gG	
ACQ80-01-132KW-4	R8	3126	10666	550	324	65	355	gG	
ACQ80-01-160KW-4	R8	4066	13874	550	324	65	425	gG	
ACQ80-01-200KW-4	R9	4834	16494	1150	677	68	500	gG	

*) Heat dissipation value is a reference for cabinet thermal design.

**) The maximum noise level at full fan speed. When the drive is not operating at full load and at maximum ambient temperature, the noise level is lower.

***) For detailed fuse sizes and types, please see the ACQ80 hardware manuals, document codes: ACQ80-01 3AXD50001017101, ACQ80-04 3AXD50000170661 and ACQ80-07 3AXD50000946440.

Drive modules, ACQ80 (3-phase supply voltage range 380-480 V) IP55

Drive type	Frame size	Cooling air flow 380 to 480 V units					Recommended input protection fuses 380 to 480 V units ***)	
		Heat dissipation *)		Airflow		Max. noise level **)	IEC fuses	
		(W)	(BTU/h)	(m ³ /h)	(ft ³ /min)	(dBA)	(A)	Fuse type
ACQ80-01-030kW-4+B056	R4	803	2740	150	88	70	80	gG
ACQ80-01-037kW-4+B056	R4	882	3010	150	88	70	100	gG
ACQ80-01-045kW-4+B056	R4	1059	3613	159	94	70	100	gG
ACQ80-01-055kW-4+B056	R5	1290	4402	139	82	63	125	gG
ACQ80-01-075KW-4+B056	R6	1960	6688	435	256	67	160	gG
ACQ80-01-090KW-4+B056	R7	2120	6896	450	265	67	250	gG
ACQ80-01-110KW-4+B056	R7	2785	9503	450	265	67	315	gG
ACQ80-01-132KW-4+B056	R8	3126	10666	550	324	65	355	gG
ACQ80-01-160KW-4+B056	R8	4066	13873,8	550	324	65	425	gG
ACQ80-01-200KW-4+B056	R9	4834	16494,3	1150	677	68	500	gG

*) Heat dissipation value is a reference for cabinet thermal design.

**) The maximum noise level at full fan speed. When the drive is not operating at full load and at maximum ambient temperature, the noise level is lower.

***) For detailed fuse sizes and types, please see the ACQ80 hardware manuals, document codes:

ACQ80-01 [3AXD50001017101](#), ACQ80-04 [3AXD50000170661](#) and ACQ80-07 [3AXD50000946440](#).

EMC – electromagnetic compatibility

What is EMC?

EMC stands for electromagnetic compatibility. It is the ability of electrical/electronic equipment to operate without problems in an electromagnetic environment.

Likewise, the equipment must not disturb or interfere with any other product or system in its locality. This is a legal requirement for all equipment in service in the European Economic Area (EEA).

Installation environments

A power drive system (PDS) can be connected to either industrial or public power distribution networks. The environment class depends on how the PDS is connected to power supply.

The 1st environment includes domestic premises. It also includes establishments directly connected without an intermediate transformer to a low-voltage power supply network that supplies buildings used for domestic purposes.

The 2nd environment includes all establishments directly connected to public low-voltage power supply networks.

EMC solutions

To fulfill the EMC requirements, the drives are equipped with standard or optional RFI filtering for HF disturbances.

- Using ferrite rings in power connection points
- Using an AC or DC choke (while they are meant to protect against harmonics, they reduce HF disturbances as well)
- Using an LCL filter in the case of regenerative drives
- Using a du/dt filter

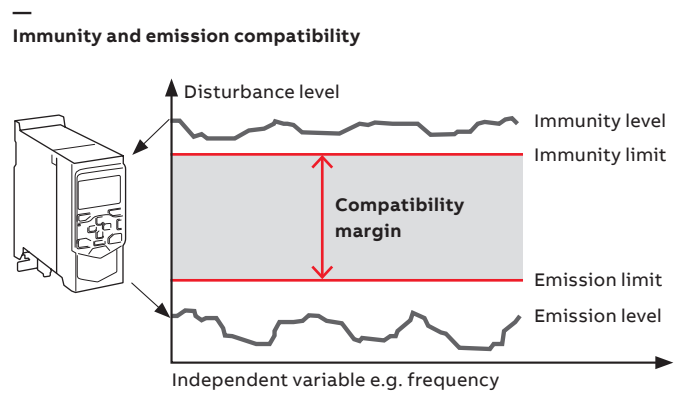

Installation environments

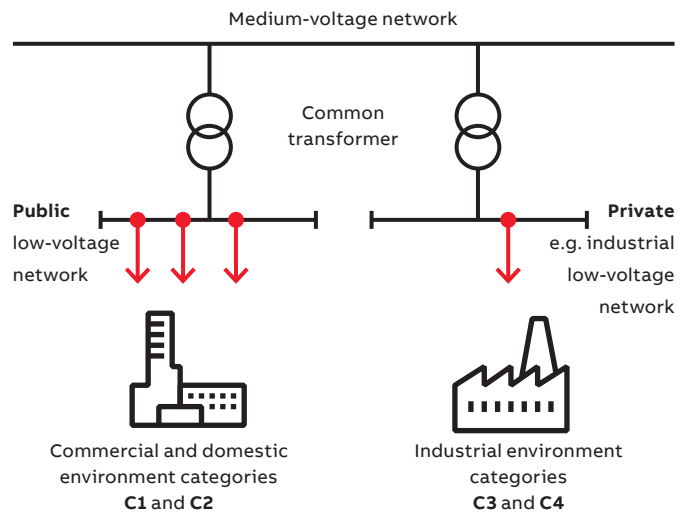

The product standard EN 61800-3 divides PDSs into four categories, according to the intended use

C1 – 1st environment

- Household appliances
- Usually plug connectible to any wall outlet
- Anyone can connect these to the network
- Examples: washing machines, TV sets, computers, microwave ovens, etc.

C2 – 1st environment

- Fixed household and public appliances
- Need to be installed or operated by a professional
- Examples: elevators, rooftop fans, residential booster pumps, gates and barriers, supermarket freezers, etc.

C3 – 2nd environment

- Professional equipment
- Needs to be installed or operated by a professional
- In some rare cases, may also be pluggable
- Examples: any equipment for industrial use only, such as conveyors, mixers, etc.

C4 – 2nd environment

- Professional equipment
- Needs to be fixed installation and operated by a professional
- Examples: paper machines, rolling mills, etc.

Input chokes, du/dt filters, C1 filters

Input chokes, du/dt filters, C1 filters

External input chokes can be used with the ACQ80 drives if there is a need to optimize the line-side harmonics. du/dt filtering, on the other hand, suppresses inverter output voltage spikes and rapid voltage changes, which stress motor insulation. Additionally, du/dt filtering reduces capacitive leakage currents and high-frequency emissions from the motor cable, as well as high-frequency losses and bearing currents in the motor. The need for du/dt filtering depends on the motor insulation.

To comply with European EMC Directive Category C1 (standard IEC/EN 61800-3) with an optional external EMC filter use motor cables with a maximum length of 10 meters for 4 kHz switching frequency. In addition, please note that Category C1 is with conducted emissions only.

External input chokes, du/dt filters, for 380 to 480 V units			
Drive type	Frame size	Input choke, max. ambient temp. 40 °C	du/dt filter type, max. ambient temp. 40 °C
ACQ80-04-0KW75-4	R0	CHK-01	ACS-CHK-B3
ACQ80-04-01KW1-4	R0	CHK-01	ACS-CHK-B3
ACQ80-04-01KW5-4	R0	CHK-02	ACS-CHK-C3
ACQ80-04-02KW2-4	R0	CHK-02	ACS-CHK-C3
ACQ80-04-03KW0-4	R0	CHK-02	NOCH0016-60
ACQ80-04-04KW0-4	R0	CHK-03	NOCH0016-60
ACQ80-04-05KW5-4	R1	CHK-03	NOCH0016-60
ACQ80-04-07KW5-4	R2	CHK-04	NOCH0030-60
ACQ80-04-011KW-4	R2	CHK-04	NOCH0030-60
ACQ80-04-015KW-4	R3	CHK-05	NOCH0030-60
ACQ80-04-18KW5-4	R3	CHK-05	NOCH0070-60
ACQ80-04-022KW-4	R3	CHK-06	NOCH0070-60
ACQ80-01-030kW-4	R4	-	NOCH-0070-60
ACQ80-01-037kW-4	R4	-	NOCH-0120-60 ^{*)}
ACQ80-01-045kW-4	R4	-	NOCH-0120-60 ^{*)}
ACQ80-01-055kW-4	R5	-	NOCH-0120-60 ^{*)}
ACQ80-01-075kW-4	R6	-	FOCH0260-70
ACQ80-01-090KW-4	R7	-	FOCH0260-70
ACQ80-01-110KW-4	R7	-	FOCH0260-70
ACQ80-01-132KW-4	R8	-	FOCH0260-70
ACQ80-01-160KW-4	R8	-	FOCH0260-70
ACQ80-01-200KW-4	R9	-	FOCH0320-50

^{*)} 3 filters included, dimensions apply to one filter.

Dimensions and weights of the du/dt filters				
du/dt filters	Height (mm)	Width (mm)	Depth (mm)	Weight (kg)
ACS-CHK-B3	296	102	111	4.5
ACS-CHK-C3	296	102	111	4.5
NOCH0016-60	195	140	115	2.4
NOCH0030-60	215	165	130	4.7
NOCH0070-60	261	180	150	9.5
NOCH-0120-60 ^{*)}	200	154	106	7
FOCH0260-70	382	340	254	47
FOCH0320-50	662	319	293	65

^{*)} 3 filters included, dimensions apply to one filter.

For information on the construction of the motor insulation, consult the manufacturer.

More information on the du/dt and C1 filters can be found in the ACQ80 hardware manuals, document codes: ACQ80-01 [3AXD50001017101](#), ACQ80-04 [3AXD50000170661](#) and ACQ80-07 [3AXD50000946440](#).

An entirely new level of ease



The assistant control panel's intuitive user interface, assistants and ready-made macros offer simplicity to your everyday life and save you time. The panel guides you through commissioning without needing to know any drive parameters and helps in unclear situations.

Assistant control panel, ACS-AP-S

Set up the drive, fine-tune motor control and monitor values that matter using the assistant control panel, delivered as standard with all ACQ80 drives.

Hassle-free commissioning

Select language, set time and date, name the drive, enter motor values, test rotating the motor.

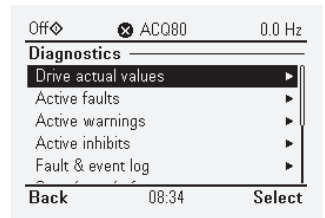
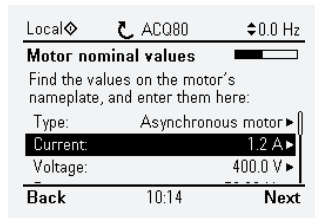
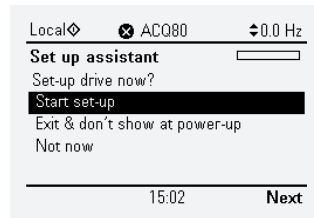

Input/output menu

Set and monitor your input/output (I/O) connections for real-time diagnostics

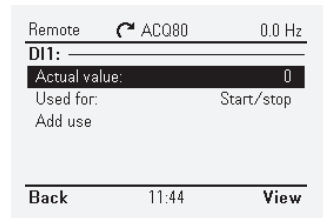
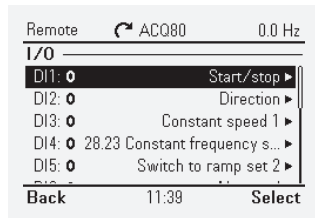
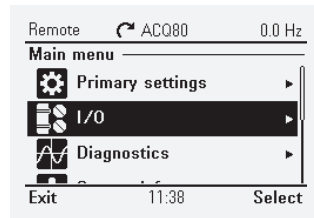

Home view displays

Monitor the values that are the most important to you. You can select values for monitoring from a ready-made list or choose user-defined parameters.

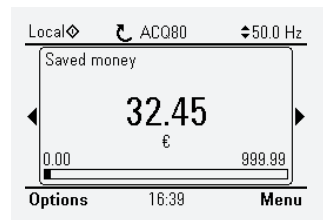
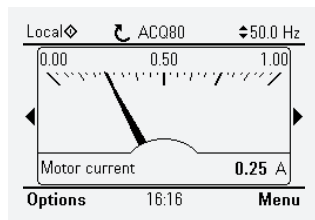
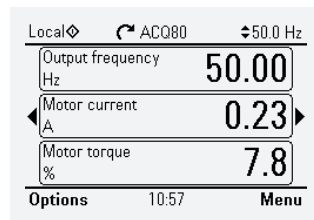

Help button

The help button provides more information about your selection, and it can be pressed in any view.

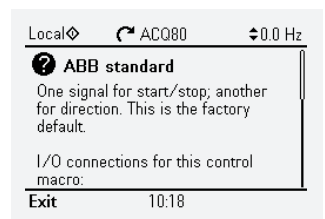
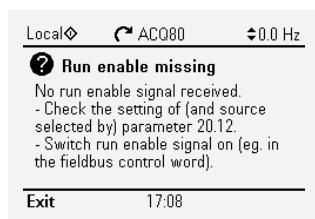
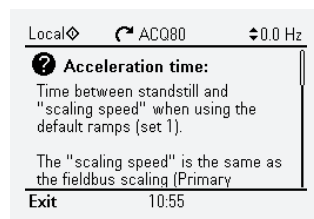



Control panel options and mounting kits

The standard delivery of the ACQ80 includes the assistant control panel, but it can be replaced by other panels using the +J ordering codes.



Bluetooth control panel, ACS-AP-W ^{*)}

The optional Bluetooth panel enables connection with the Drivetune mobile app. The app is available for free from Google Play and the Apple App store. Combined with the Drivetune app and the Bluetooth panel, users can commission and monitor the drive remotely, for example.



Control panel mounting platform, DPMP-01

This mounting platform is for flush mountings. This also requires RDUM-01 (blank control panel with the RJ-45 connector) and a control panel (assistant, basic, Bluetooth or industrial).



Basic control panel, ACS-BP-S

The icon-based control panel supports users with parameter backup, settings and fault tracking in basic operation.



Control panel mounting platform, DPMP-02

This mounting platform is for surface mountings. This also requires RDUM-01 (blank control panel with the RJ-45 connector) and a control panel (assistant, basic, Bluetooth or industrial).



Blank control panel cover with RJ-45 connector, RDUM-01

The RDUM-01 panel is used in cabinet installations to connect the assistant control panel, basic control panel, or Bluetooth control panel on the cabinet door to the drive with the RJ-45 cable.



Door mounting kit, DPMP-EXT2

The door mounting kit is ideal for cabinet installations. A kit for one drive includes one DPMP-02 and one RDUM-01 (blank control panel cover with RJ-45 connector).



Industrial control panel, ACS-AP-I ^{*)}

The industrial control panel is compatible with all ABB drives, making it simple to use a single panel with different products.



Control panel bus adapters, CDPI-02

Control panel bus adapters are used to connect control panels with a RJ-45 cable to the drive from a distance, e.g. when mounting the control panel on a cabinet door. In addition, CDPI adapters can be used to daisy chain several drives together to be controlled with a single control panel or PC tool.



Control panel mounting kit for outdoor installation, DPMP-04/05

Enables control panel outdoor mounting thanks to IP66 protection class, UV resistance and IK07 impact protection rating.

^{*)} Also compatible with other ABB all-compatible drives: ACS380, ACS480, ACS580, and ACS880 drives.

ACQ80 drives are optimized especially for cabinet installations. Uniform height and depth across the full power range allow easy installation using a single rail inside the cabinet, and side-by-side mounting saves space and enables smaller cabinets to be used. The door mounting kit simplifies drive operation, as the control panel is easy to mount on the cabinet door.

Control panel options			
Loose option code	Plus code	Description	Type designation
3AUA0000064884	-	Assistant control panel as standard	ACS-AP-S
3AUA0000088311	+J425	Industrial Assistant control panel	ACS-AP-I
3AXD50000025965	+J429	Control panel with Bluetooth interface	ACS-AP-W
3AXD50000028828	+J404	Basic control panel	ACS-BP-S
3AXD50000040850	+J424	Blank control panel cover with RJ-45 connector	RDUM-01
3AUA0000108878	-	Control panel mounting platform (flush-mounted, also requires panel bus adapter on the drive)	DPMP-01
3AXD50000009374	-	Control panel mounting platform (surface-mounted, also requires panel bus adapter on the drive)	DPMP-02
3AXD50000048730	-	Door mounting kit for the panel (for one drive, contains DPMP-02 and RDUM-01)	DPMP-EXT2
3AXD50000275595	-	Panel bus adapter	CDPI-02
3AXD50000217717	-	Control panel mounting kit for outdoor installation	DPMP-04
+OJ400	If no control panel is needed, the assistant control panel can be left out of the standard delivery.		



ABB Ability™ Mobile Connect for drives

Easy access to remote support

ABB Ability™ Mobile Connect for drives is a platform for remote drive support consisting of the Mobile Connect web portal and the Drivetune mobile app.

The platform allows ABB service partners to provide remote commissioning and troubleshooting support for personnel on-site without any complex connectivity infrastructure. Chats, sharing images and backups, viewing parameters online and sending support packages

are all possible, making your technical support process quick and efficient.

All that is needed is the Bluetooth control panel and a mobile device.

The platform is available for ABB partners and OEMs under a renewable subscription-based agreement.

[ABB Ability™ Mobile Connect for drives support portal](#)

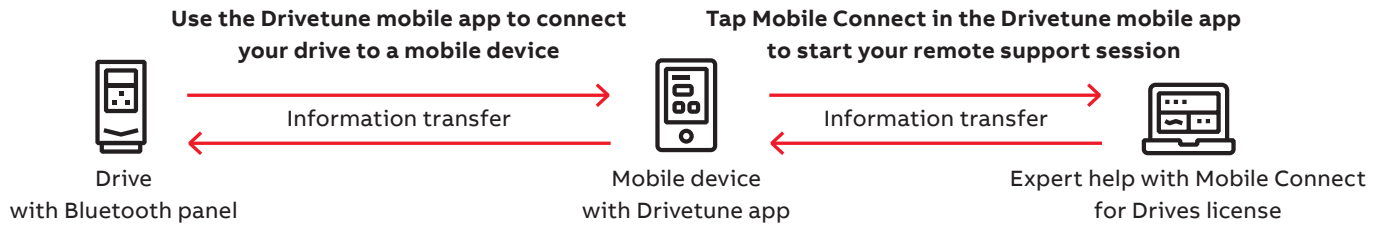

Drivetune mobile app for managing drives via an intuitive interface

Drivetune mobile app is a powerful tool for performing basic drive startup and troubleshooting tasks. It is possible to connect with drives and access data available in the Internet at the same time. The wireless Bluetooth

connectivity means that users won't need to enter hazardous or difficult-to-reach work areas to access information necessary to help them commission and tune the drive.



- **Startup, commission and tune your drive and application with full parameter access**
- **Optimize performance via drive troubleshooting features**
- **Create and share backups and support packages**
- **Keep track of drives installed base**

Download Drivetune mobile app



ABB Ability™ Digital Powertrain

Condition monitoring for drives



Accurate, real-time information about powertrain events. When you have the facts, you can make the right decisions.

Condition Monitoring gives you fact-based insight into your powertrain assets, such as drives and motors, via KPIs and signal data, to identify irregularities before they become problems. This helps you make proactive decisions, built on real-time information – and saves you money!

The service can be tailored to fit your needs

Our standard package gives you industry leading monitoring capabilities – whether you want to view the drive status through ABB's Internet portal or integrate this data with your existing monitoring systems.

The standard package includes the following services:

- Condition Monitoring
- Alarm Management
- Asset Health
- Team Support
- Backup Management

The standard package can be supplemented with optional services:

- Offline Data Collection
- Expert Reports
- Remote Assistance
- Condition monitoring of your entire powertrain



Solid fact-based decision making

Get the facts, and the history, to help run your operations better and more safely.



Always stay one step ahead of problems

Recognize early signs of possible failures and assess the risks, before they turn into serious operational issues.



Find the root cause of process issues

Remotely access data from ABB drives built-in sensors to track the cause of problems. Get back to smooth operation quickly with data back-ups.



Remotely analyze and optimize drives

Get critical drive information anywhere anytime – even in difficult to access sites, or when a site visit is impossible.

Communication and I/O options

Fieldbus adapter modules

The ACQ80 drives come with Modbus RTU communication protocol as standard, and there is also a wide range of optional fieldbus protocols available.

Fieldbus communication reduces wiring costs compared to traditional hardwired input/output connections. The fieldbus options can be installed into the slot one (1).

Input/output extension modules

Standard inputs and outputs of ACQ80-01 and -07 can be extended by using optional input/output extension modules installed in the slot two (2) on the drive. Standard inputs and outputs of ACQ80-04 (RIIO-01 module) can be easily reduced by removing the module or changing it to reduced I/O module (BIO-01). The modules are easily installed in the extension slot two (2) located on the drive.

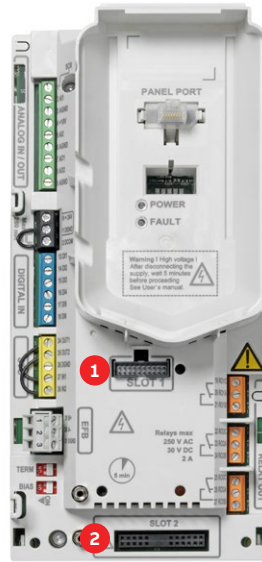

ACQ80-01/07 control unit



ACQ80-04 control unit

ACQ80-04 I/O options



BIO-01



RIIO-01

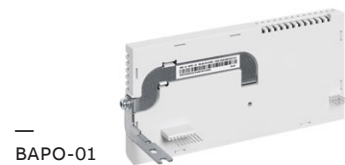

BAPO-01
BREL-01

ACQ80-01 and -07 I/O options



CMOD-01



CMOD-02



CAIO-01



CHDI-01

ACQ80-04 I/O options

Plus code	MRP code	Description	Type designation
+L504	3AXD50000033791	RIIO-01 I/O extension module coming as standard and including EIA-485 interface (Modbus RTU), 2 analog inputs, 2 analog outputs, 4 digital inputs, 2 relay outputs, 1 auxiliary voltage output 24 V DC *)	RIIO-01
+L515	3AXD50000191635	Reduced I/O extension module including 3 digital inputs, 1 digital output and 1 analog input **)	BIO-01
+L534	3AXD50000022164	Auxiliary power extension module enables the use of an external auxiliary power supply with the drive	BAPO-01
+L511	3AXD50000022162	Relay output extension module adds 4 relay outputs to the drive	BREL-01
+OL540	-	Removes standard I/O module RIIO-01 leaving only the base unit I/O connections (2 digital inputs, 1 relay output, STO, 1 auxiliary voltage output 24 V DC)	-

*) Standard I/O extension module RIIO-01 cannot be used together with reduced I/O extension module BIO-01 or with a fieldbus adapter.

**) BIO-01 reduced I/O extension allows simultaneous use of fieldbus adapter.

ACQ80-01 and -07 I/O options

Plus code	MRP code	Description	Type designation
+L501	3AXD50000004420	External 24 V AC and DC 2 x RO and 1 x DO	CMOD-01
+L523	3AXD50000004418	External 24 V and isolated PTC interface	CMOD-02
+L512	3AXD50000004431	115/230 V digital input 6 x DI and 2 x RO	CHDI-01
+L525	3AXD50000709243	Analogue signal extension 3 x AI and 2 x AO	CAIO-01

Note: For more information see hardware manuals, document codes: ACQ80-01 [3AXD50001017101](#), ACQ80-04 [3AXD50000170661](#) and ACQ80-07 [3AXD50000946440](#).

Fieldbus options

Plus code	MRP code	Fieldbus protocol	Adapter
+K458	3AUA0000031336	Modbus RTU	FSCA-01
+K454	68469325	PROFIBUS DP. DPV0/DPV1	FPBA-01
+K457	68469376	CANopen®	FCAN-01
+K469	3AUA0000072069	EtherCAT®	FECA-01
+K491	3AXD50000049964	Two port Modbus/TCP	FMBT-21
+K492	3AXD50000192779	Two port PROFINET IO	FPNO-21



ABB GoSelect web-based tool

Build the optimal solution for your application quickly and easily online

ABB GoSelect is a web-based selection and dimensioning tool for motors, drives, and PLCs. Build the optimal solution for your application and efficiently create, collect, and manage documentation and reports – all in one place.

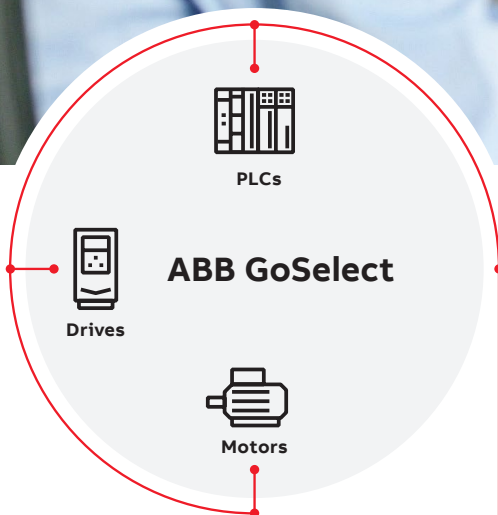

Improved productivity

ABB GoSelect's modern, intuitive interface is easy to use. You can start by following the guided selection journey to get help finding the most suitable products. If you have already identified the right product for your application, you can proceed directly to sizing. The tool can also be used to validate the selected solution directly.



All in one place

With ABB GoSelect you can select, dimension, and validate your solution – all-in-one convenient online portal, with or without logging in. No more searching and saving links or skipping between different tools. The tool eliminates the need to duplicate input data across multiple tools, bringing all your project documentation together in one place. No more wasted time.



Efficient collaboration

With ABB GoSelect, the whole team can provide their input in one place in real time. You can create different alternatives in one project to make it easy to compare your options and track the project history. No more time-consuming and confusing file exchanges via email.

For more information, see:
goselect.motion.abb.com



Tools for configuration, monitoring and process tuning

Enjoy the ease offered by the cold configuration and Drive Composer PC tools. These tools lighten your workload, especially if there are many drives. The cold configurator tool provides a quick way to parametrize unpowered drives even in their boxes, and the Drive Composer PC tool offers advanced means for commissioning and monitoring, for example.

Safe configuration for unpowered drives

The CCA-01 cold configuration adapter provides a serial communication interface for unpowered drives. With the adapter, safety isolation of both serial communication and the control board power supply is possible. The power supply is taken from a PC USB port.

Cold configurator



Users can download the software and parameters to drives without powering the drive.

MRP code	Description	Type designation
3AXD50000019865	Cold configurator adapter, packed kit	CCA-01

Adaptive programming

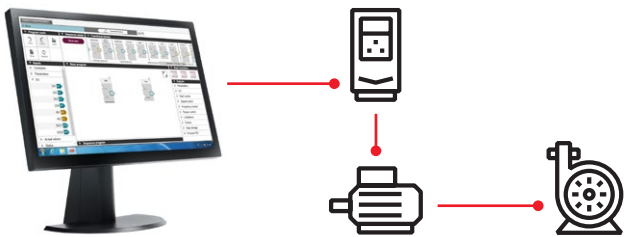

Adaptive programming

Adaptive programming software, embedded inside the drive, is especially handy when there is a need to distribute some of the machine's control logic to the drive. Adaptive programming brings energy savings when the drive is adjusted to control the application optimally. You can use our Drive Composer pro PC tool to set up the adaptive programming. The drive also offers sequence programming capabilities. Adaptive programming makes it possible to enhance the existing application control program to precisely fit users' application needs. The program is also handy for ensuring that the drive's electrical design is connected as it should be with working drive signals.

Drive Composer

The Drive Composer PC tool offers fast and harmonized setup, commissioning and monitoring for all-compatible drives. The free version of the tool provides startup and maintenance capabilities, and gathers all drive information such as parameter loggers, faults, backups and lists into a support diagnostics file. Drive Composer pro provides additional features such as custom parameter windows, graphical control diagrams of the drive's configuration, and improved monitoring and diagnostics.

Drive Composer	Entry level (free)	Pro level
	Basic functionality	Entry-level features
	Parameter setting	Networked drives
	Point-to-point connection	Control diagrams
	Simple monitoring	Data logger(s)
	Supports adaptive programming	Graphical safety setup
	-	Multiple backup and restore
	-	Adaptive (block) programming
-	Drive configuration by using virtual drive	

Link/MRP codes	Description	Type designation
new.abb.com/drives/software-tools/drive-composer	Link to download free Drive Composer entry	-
9AKK105408A3415	Drive Composer entry PC tool (document)	-
3AUA0000108087	Drive Composer pro PC tool (single-user license)	DCPT-01
3AUA0000145150	Drive Composer pro PC tool (10-users license)	DCPT-01
3AUA0000145151	Drive Composer pro PC tool (20-users license)	DCPT-01

All-compatible ACQ80 solar pump drive

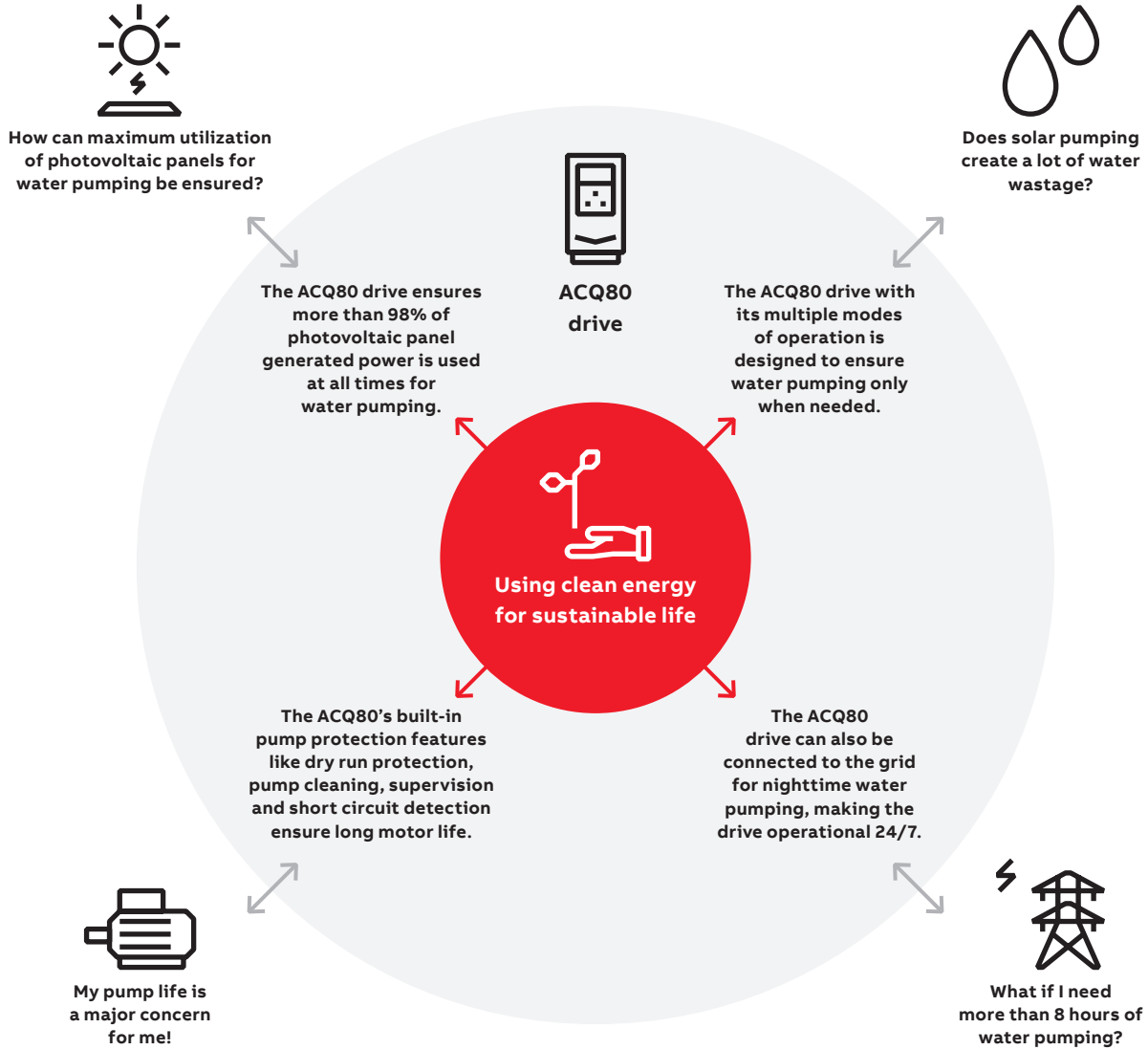

Connection representation

Representation of the drive's typical connection.

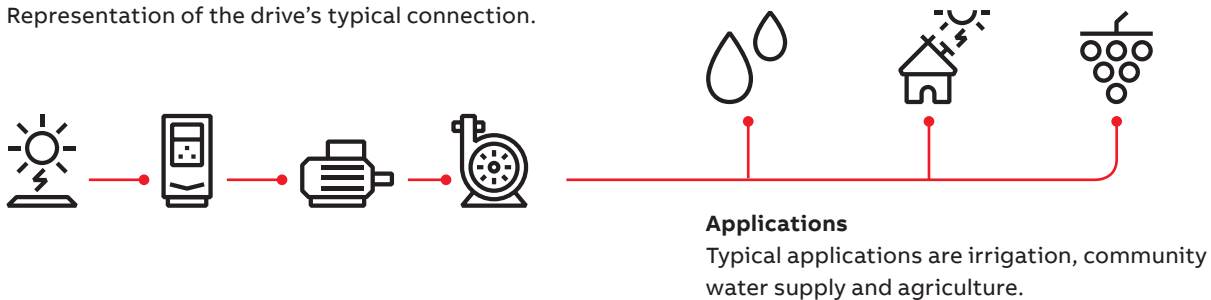

Summary of drive ordering codes

ACQ80-04

The type designation tells you the specifications and configuration of the drive.

The table shows the primary drive variants.

Sample type code: ACQ80-04-01KW5-4+XXXX

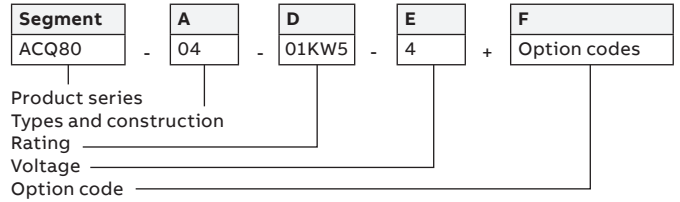

Basic codes			
Segment	Option		Description
A	Construction	04 = when no options are selected: drive module, IP20 (UL type open), ACS-AP-S control panel with a USB port, Modbus RTU as part of RIIO-01 I/O standard module, internal EMC C2 filter, Safe Torque Off (STO), brake chopper, coated boards, quick installation and start-up guide (multilingual).	
D	Power rating		Refer to the rating table
E	Voltage rating		4 = 400/480 V (380...480 V)
Option codes			
Segment	Option	Code	Description
F	Control panel and panel options	+0J400	No control panel
		+J400	ACS-AP-S assistant control panel (as standard)
		+J424	Blank panel with RJ-45 connector (RDUM-01)
		+J425	ACS-AP-I industrial assistant control panel
		+J429	ACS-AP-W assistant control panel with a Bluetooth interface
		+J431	USB to RJ-45 cable that is used together with RDUM-01 for PC connection
	I/O (one slot available for I/O options)	+L540	I/O & Modbus RTU, module RIIO-01 (as standard)
		+0L540	Remove the standard I/O module RIIO-01
		+L515	BIO-01 reduced I/O module (can be used together with fieldbus adapter)
	I/O (one slot available for FBA options)	+K454	PROFIBUS® DP (FPBA-01)
		+K457	CANopen® (FCAN-01)
		+K458	Modbus RTU (FSCA-01)
		+K469	EtherCAT® (FECA-01)
+K491		Modbus®/TCP (FMBT-21)	
+K492		PROFINET® IO (FPNO-21)	
Software	+N2000	Standard language package	

Side I/O options BREL-01 (relay option: 4xRO) and BAPO-01 (External +24 DC option) are available as loose items only. Only one slot for side I/O option is available. For other options please contact local ABB.

Summary of drive ordering codes

ACQ80-01

The type designation tells you the specifications and configuration of the drive.

The table shows the primary drive variants.

Sample type code: ACQ80-01-037KW-4+XXXX

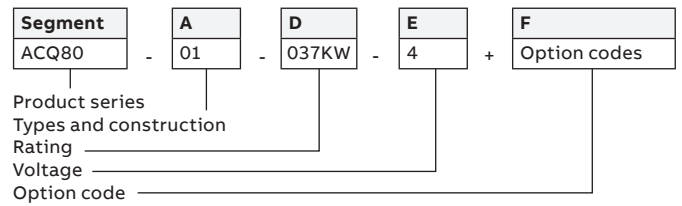

Basic codes			
Segment	Option		Description
A	Construction	01 = when no options are selected: wall-mounted drive, IP21 (UL Type 1), ACS-AP-S control panel with a USB port, embedded Modbus RTU, choke, internal EMC C2 filter, Safe Torque Off (STO), coated boards, cable lead through entry from the bottom, cable box or the conduit plate with cable entries, quick installation and start-up guide (multilingual).	
D	Power rating		Refer to the rating table
E	Voltage rating		4 = 400/480 V (380...480 V)
Option codes			
Segment	Option	Code	Description
F	Control panel and panel options	+J400	ACS-AP-S assistant control panel (as standard)
		+OJ400	Removes control panel
		+J424	CDUM-01 blank control panel cover (no control panel)
		+J425	ACS-AP-I industrial assistant control panel
		+J429	ACS-AP-W assistant control panel with a Bluetooth interface
	I/O (one slot available for I/O options)	+L501	CMOD-01 external 24 V AC/DC and digital I/O extension (2×RO and 1×DO)
		+L512	CHDI-01 115/230 V digital input extension (6×DI and 2×RO)
		+L523	CMOD-02 external 24 V AC/DC and isolated PTC interface
		+L525	CAIO-01 analogue signal extension (3 x AI and 2 x AO)
	Fieldbus	+K454	PROFIBUS® DP (FPBA-01)
+K457		CANopen® (FCAN-01)	
+K458		Modbus RTU (FSCA-01)	
+K469		EtherCAT® (FECA-01)	
+K491		Modbus®/TCP (FMBT-21)	
+K492		PROFINET® IO (FPNO-21)	
IP enclosure	+B056	IP55 (UL type 12). Factory option, retrofit not possible.	
Construction	+H358	Cable conduit plate, blank	
	+P944	Drive without cable entry box. Version for cabinet mounting (R5-R9).	
Complementary options	+P931	Extended warranty up to 36 months	
	+P932	Extended warranty up to 60 months	
	+P952	European Union Country of origin	
Software	+N2000	Standard language package	

Summary of drive ordering codes

ACQ80-07

The type designation tells you the specifications and configuration of the drive.

The table shows the primary drive variants.

Sample type code: ACQ80-07-075KW-4+XXXX

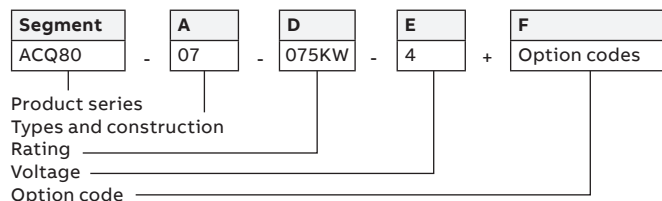

Basic codes			
Segment	Option		Description
A	Construction		07 = when no options are selected: cabinet-installed drive, IP21 (UL Type 1), ACS-AP-S control panel with a USB port, embedded Modbus RTU, main switch, AC fuses, internal EMC C2 filter (TN grounded) in frames R6 to R9, internal EMC C3 filter (TN grounded) in frames R10 and R11, Safe Torque Off (STO), bottom entry and exit of cables, USB memory containing all manuals.
D	Power rating		Refer to the rating table
E	Voltage rating		4 = 400/480 V (380...480 V)
Option codes			
Segment	Option	Code	Description
F	Control panel and panel options	+J400	ACS-AP-S assistant control panel (as standard)
		+0J400	Removes control panel
		+J424	CDUM-01 blank control panel cover (no control panel)
		+J425	ACS-AP-I industrial assistant control panel
		+J429	ACS-AP-W assistant control panel with a Bluetooth interface
	I/O (one slot available for I/O options)	+L501	External 24 V DC/AC and Digital I/O extension (2xRO and 1xDO)
		+L504	Additional I/O-Terminal Block
		+L512	115/230V Digital input (6xDI and 2xRO)
		+L523	External 24 V and isolated PTC interface
		+L525	CAIO-01 analogue signal extension (3 x AI and 2 x AO)
Safety	+Q951	Safety option of emergency stop where Main breaker is opened during emergency	
	+Q963	Safety option of emergency stop where main breaker is not opened during emergency	
Fieldbus	+K454	PROFIBUS® DP (FPBA-01)	
	+K457	CANopen® (FCAN-01)	
	+K458	Modbus RTU (FSCA-01)	
	+K469	EtherCAT® (FECA-01)	
	+K491	Modbus®/TCP (FMBT-21)	
	+K492	PROFINET® IO (FPNO-21)	
IP enclosure	+B054	IP42 (UL Type 1)	
	+B055	IP54 (UL Type 12)	
Filters, contactors, circuit breakers	+E205	Du/dt filter	
	+E208	Common mode filter (as a default for R10-R11)	
	+F250	Line contactor	
Complementary options	+P931	Extended warranty up to 36 months	
	+P932	Extended warranty up to 60 months	
Software	+N2000	Standard language package	



Our service expertise, your advantage

ABB Motion Services helps customers around the globe by maximizing uptime, extending product life cycle, and enhancing the performance and energy efficiency of electrical motion solutions. We enable innovation and success through digitalization by securely connecting and monitoring our customers' motors and drives, increasing operational uptime, and improving efficiency. We make the difference for our customers and partners every day by keeping their operations running profitably, safely and reliably.

With a service offering tailored to your needs, ABB Motion Services maximizes the uptime and extends the life cycle of your electrical motion solutions, while optimizing their performance and maximizing your energy efficiency gains throughout the entire lifetime of your applications. We help to keep your applications turning profitably, safely and reliably.

Digitalization enables new smart and secured ways to prevent unexpected downtime while optimizing the operation and maintenance of your assets. We securely connect and monitor your motors, drives or your entire powertrain via our easy-to-use cloud service solutions. Connecting your applications also gives you access to our in-depth service domain expertise.

We quickly respond to your service needs. Together with our partners, local field service experts, and service workshop networks, we provide and install original spare parts to help resolve any issues and minimize the impact of unexpected disruptions.

Our tailored to your needs service offerings and digital solutions will enable you to unlock new possibilities. Not only are we your premier supplier of motion equipment, we are your trusted partner and advisor offering support throughout the entire life cycle of your assets. We ensure your operations run profitably, safely and reliably and continue to drive real world results, now and in the future. Our service teams work with you, delivering the expertise needed to keep your world turning while saving energy every day.



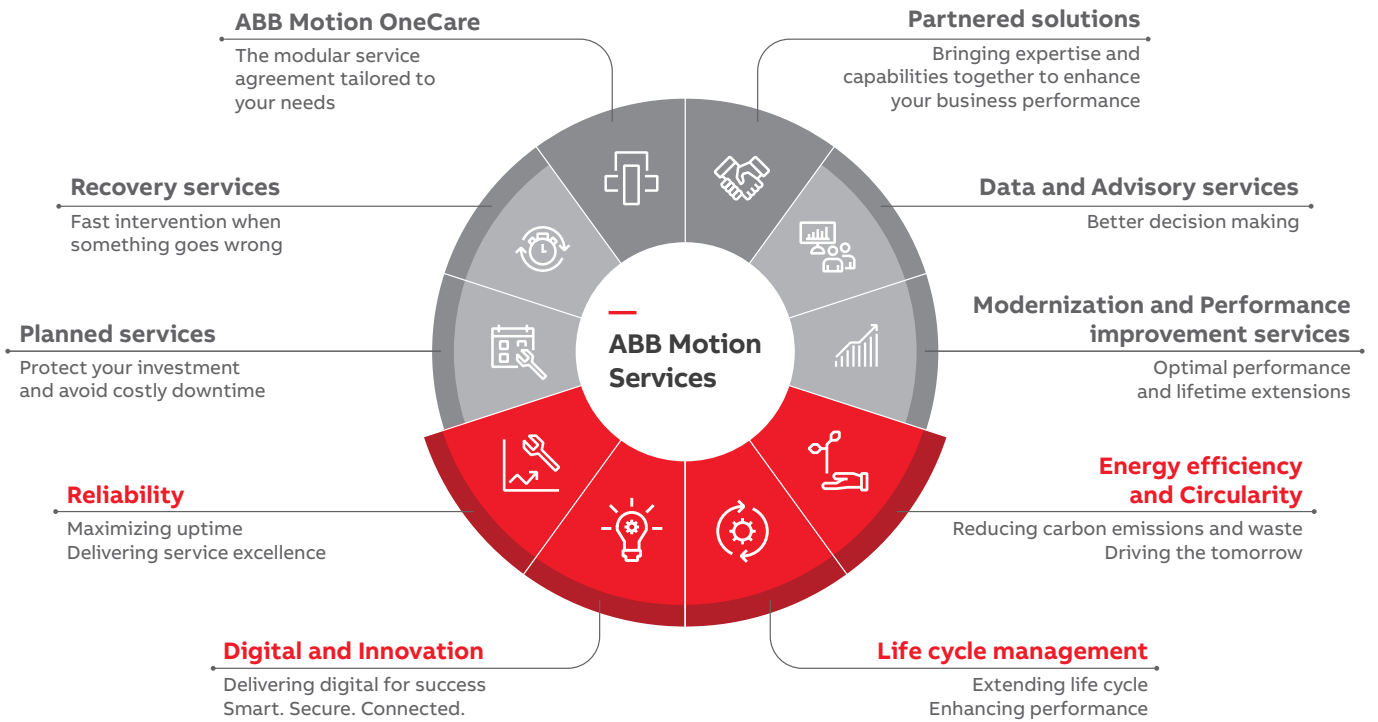

OUR EXPERTISE
YOUR ADVANTAGE



ABB Drives Life Cycle Management

A life time of peak performance

You're in control of every life cycle phase of your drives. At the heart of drive services is a four-phase product life cycle management model. This model defines the services recommended and available throughout drives lifespan.

Now it's easy for you to see the exact service and maintenance available for your drives.

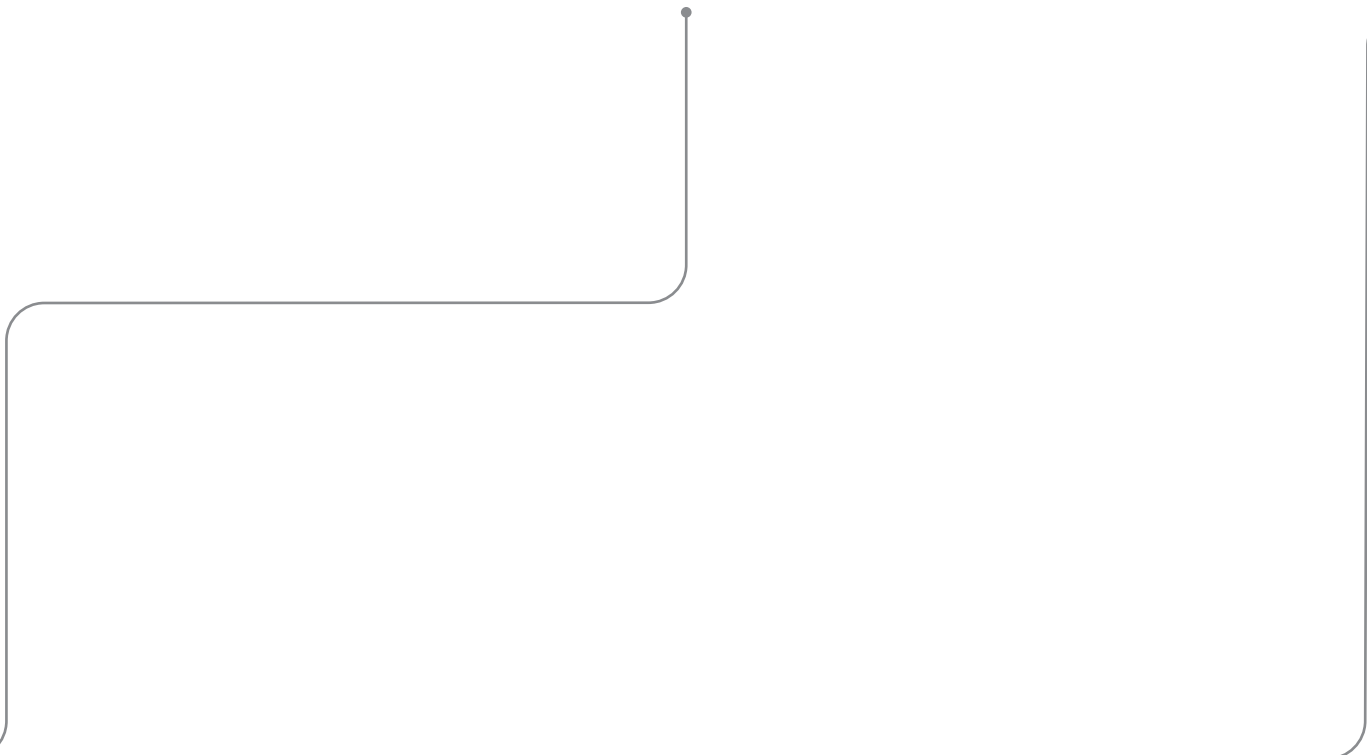
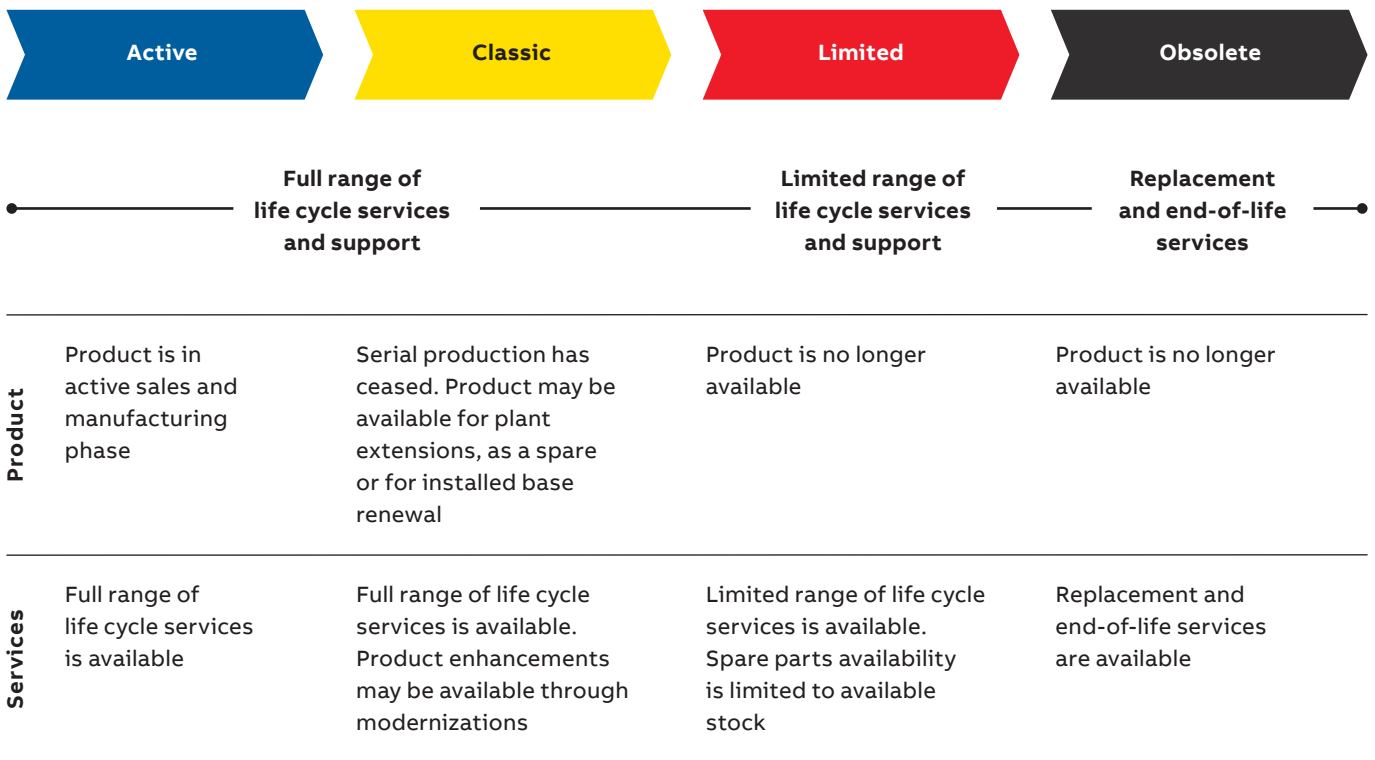

Keeping you informed throughout the life cycle

We notify you every step of the way using life cycle status statements and announcements.

Your benefit is clear information about your drives' status and precise services available. It helps you plan the preferred service actions ahead of time and make sure that continuous support is always available.

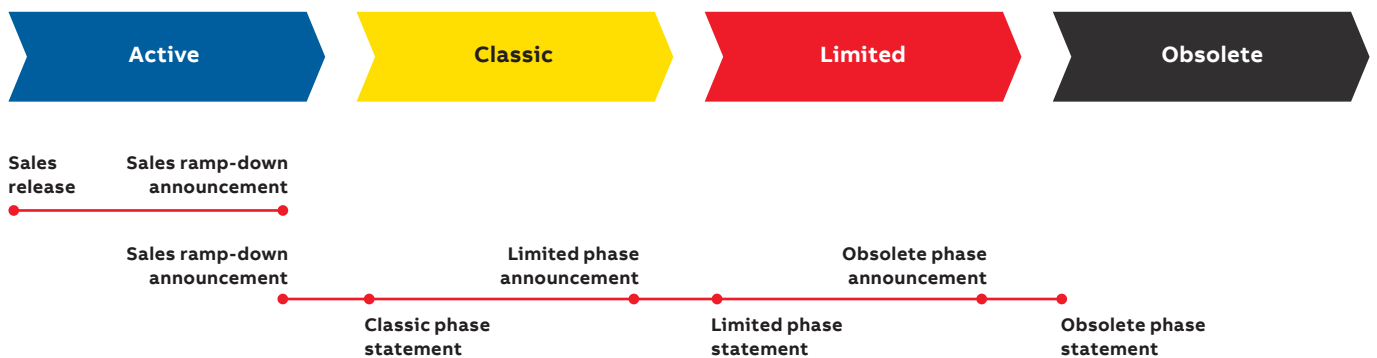

Sales release

Details about product portfolio and release schedule.

Sales ramp down announcement

Last time buy and last deliveries dates, informed well in advance.

Life cycle phase change announcement

Early information about the upcoming life cycle phase change and affects on the service availability. Informed well in advance, minimum six months prior to the change.

Life cycle phase statement

Information about the current life cycle status, product and services availability and recommended actions. Plan for the next life cycle phase transition.

Additional information

We reserve the right to make technical changes or modify the contents of this document without prior notice. With regard to purchase orders, the agreed particulars shall prevail. ABB does not accept any responsibility whatsoever for potential errors or possible lack of information in this document.

We reserve all rights in this document and in the subject matter and illustrations contained therein. Any reproduction, disclosure to third parties or utilization of its contents – in whole or in parts – is forbidden without prior written consent of ABB.



—
For more information, please contact
your local ABB representative or visit

new.abb.com/drives/ACQ80-solar-pump
new.abb.com/drives
new.abb.com/drives/drivespartners
new.abb.com/motors-generators

—
Learn more from
ACQ80, solar pump drive website.



—
Learn more from
Drives website.

